

Akuvox Smart
Intercom

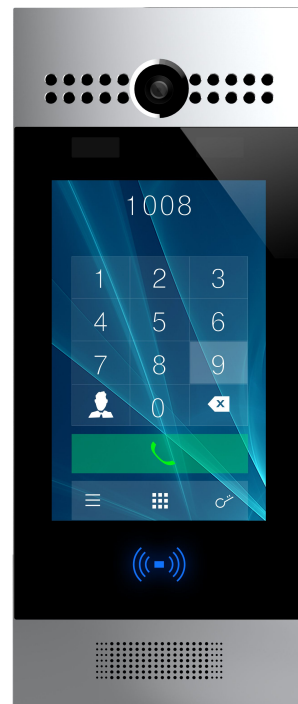

R29 Series Door Phone Admin Guide

About This Manual

Thank you for choosing Akuvox's R29 series door phone. This manual is intended for end users who need to properly configure the door phone. This manual is applicable to 29.0.1.xx version, and it provides all functions' configurations of R29 series door phone. Please visit Akuvox forum or consult technical support for any new information or latest firmware.

Note: Please refer to universal abbreviation form in the end of manual when meet any abbreviation letter.

Content

1. Product Overview	1
1.1. Instruction.....	1
1.2. Connector Introduction.....	2
1.3. Warning.....	3
2. Daily use	4
2.1. Make a Call.....	4
2.1.1. Call From Digital Keypad.....	4
2.1.2. Call From Phonebook.....	4
2.2. Receive a Call.....	5
2.3. Unlock.....	5
2.3.1. Unlock by Pin Codes.....	5
2.3.2. Unlock by Face.....	5
2.3.3. Unlock by RFID cards.....	6
2.3.4. Unlock by DTMF codes.....	6
3. Basic Features	7
3.1. Access the system setting.....	7

3.2. Access the website setting.....	7
3.2.1. Obtain IP Address.....	7
3.2.2. Access the Device Website.....	8
3.3. Password Modification.....	8
3.3.1. Modify the Phone System Password.....	8
3.3.2. Modify the Web Password.....	9
3.4. Phone configuration.....	10
3.4.1. Language.....	10
3.4.1.1. Modify the phone language.....	10
3.4.1.2. Modify the web language.....	10
3.4.2. Time.....	11
3.4.3. Network.....	11
3.4.3.1. DHCP Mode.....	11
3.4.3.2. Static Mode.....	12
3.4.4. Display.....	13
3.4.4.1. Await.....	13
3.4.4.2. Upload ScreenSaver.....	14

3.4.4.3. Door Setting General.....	15
3.4.4.4. Home View Visible Control.....	16
3.4.5. Volume.....	16
3.4.6. DND.....	18
3.5. Phonebook.....	19
3.6. Intercom call.....	22
3.6.1. IP Direct Call.....	22
3.6.2. SIP Call.....	23
3.6.2.1. Account.....	23
3.6.2.2. SIP Account.....	24
3.6.2.3. SIP Server.....	26
3.6.2.4. Outbound Proxy Server.....	26
3.6.2.5. Transport Type.....	27
3.6.3. Dial Plan.....	27
3.6.4. Quick Dial.....	29
3.6.5. Auto Answer.....	29
3.6.6. No Answer Call.....	30

3.6.7. Web Call.....	30
3.7. Security.....	31
3.7.1. Mjpeg Service.....	31
3.7.2. Live Stream.....	31
3.7.3. RTSP.....	32
3.7.4. ONVIF.....	33
3.8. Access control.....	33
3.8.1. Relay.....	33
3.8.2. Unlock via RFID Cards.....	35
3.8.2.1. RFID Cards in devices.....	35
3.8.2.2. RFID Cards in website.....	36
3.8.3. Unlock via Pin Codes.....	37
3.8.3.1. Private Pin Codes in Device.....	37
3.8.3.2. Private Pin Codes in website.....	38
3.8.3.3. Public Pin Codes in device.....	39
3.8.3.4. Public Pin Codes in websites.....	39
3.8.4. Unlock via Face.....	40

3.8.4.1. Face in Device.....	40
3.8.4.2. Face in Website.....	40
3.8.5. Unlock via HTTP Command.....	42
3.8.6. Unlock via Exit Button.....	43
3.9. Reboot.....	44
3.10. Reset.....	45
4. Advanced Features.....	46
4.1. Phone Configuration.....	46
4.1.1. IR LED.....	46
4.1.2. LED of Display.....	47
4.1.3. RFID Card Code Display Related.....	47
4.2. Intercom.....	48
4.2.1. Call Time Related.....	48
4.2.2. Return Code When Refused.....	49
4.2.3. SIP Call Related.....	49
4.2.4. Call Waiting.....	50
4.2.5. Intercom.....	51

4.2.6. Codec.....	52
4.2.7. DTMF.....	53
4.2.8. Session Timer.....	54
4.2.9. NAT.....	54
4.2.10. User Agent.....	55
4.3. Access control.....	56
4.3.1. Webrelay.....	56
4.3.2. Wiegand.....	57
4.4. Security.....	58
4.4.1. Antialarm of Door Phone.....	58
4.4.1.1. Antialarm in device.....	58
4.4.1.2. Antialarm in website.....	59
4.4.2. Motion.....	60
4.4.2.1. Motion in device.....	60
4.4.2.2. Motion in website.....	61
4.4.3. Action.....	62
4.4.3.1. Email Notification.....	62

4.4.3.2. FTP Notification.....	63
4.4.3.3. Input Interface Triggered Action.....	63
4.5. Upgrade.....	64
4.5.1. Web Update.....	64
4.5.2. Autop Upgrade.....	64
4.5.3. Backup Config File.....	66
4.6. Log.....	67
4.6.1. Call Log.....	67
4.6.2. Door Log.....	67
4.6.3. System Log.....	68
4.6.4. PCAP.....	68

1. Product Overview

1.1. Instruction

R29 series is an Android-based IP video door phone with a touch screen. It incorporates audio and video communications, access control and video surveillance.

Its finely-tuned Android OS allows for feature customization to better suit the habit of usage of local people. R29S's multiple ports, such as RS485 and Wiegand ports, can be used to easily integrate external digital systems, such as elevator controller and fire alarm detector, helping to create a holistic control of building entrance and its surroundings and giving occupants a great sense of security.

It is applicable to multi-storey residential buildings, high-rise office buildings and their complexes.

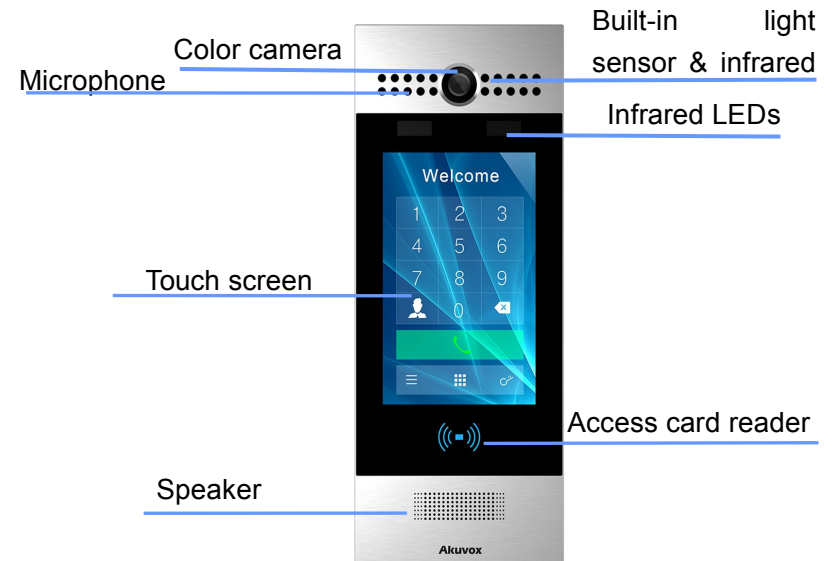

Figure 1.1 Product Description

1.2. Connector Introduction

Ethernet (POE): Ethernet (POE) connector which can provide both power and network connection.

12V/GND: External power supply terminal if POE is not available.

WG_D0/1: Wiegand terminal for wiegand access control.

RS485A/B: RS485 terminal for automation system control (e.g. Elevator control).

DOORA/B/C: Trigger signal input terminal (e.g. Press indoor button to open relay).

RelayA/B/C: NO/NC Relay control terminal.

Note: The general door phone interface diagram is only for reference.

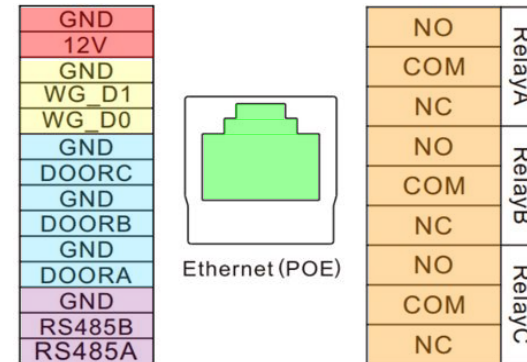

Figure 1.2-1 Connection introduction

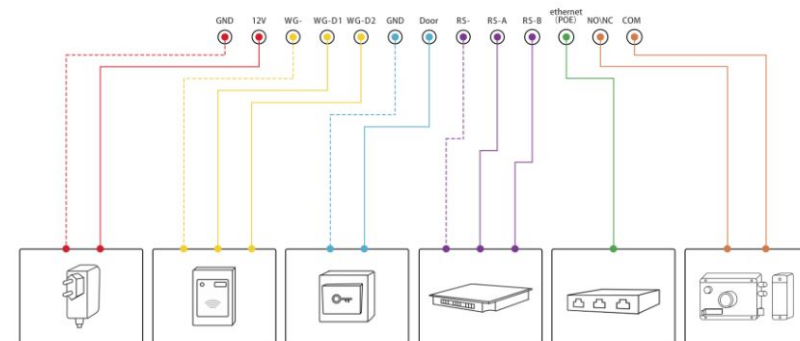

Figure 1.2-2 General interface

1.3. Warning

Please don't place R29S/F to direct sunlight, it will bring a bad effect or be broken with the high temperature.

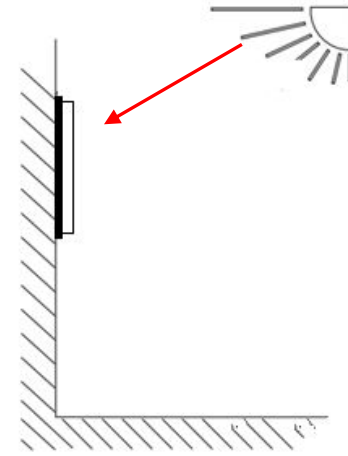

Figure 1.3 Direct sunlight diagram

2. Daily use

2.1. Make a Call

There are two ways to make a call from the door phone to monitor units, which can be an indoor monitor or an intercom app.

2.1.1. Call From Digital Keypad

The default interface of the door phone is the dial interface. Enter the number to call on the digital keypad, and press the dial icon.

2.1.2. Call From Phonebook

In the phonebook interface, to find a specific occupant, scroll up or down the pre-imported contact list, which is either a room number, an occupant's name, or the combination of both. It also supports searching the list by alphabet and then clicking the dial key next to the found contact.

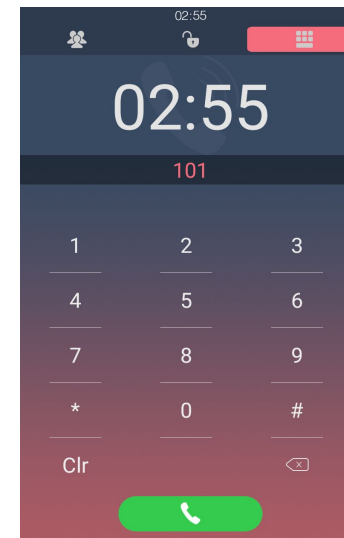

Figure 2.1.1 Dial interface

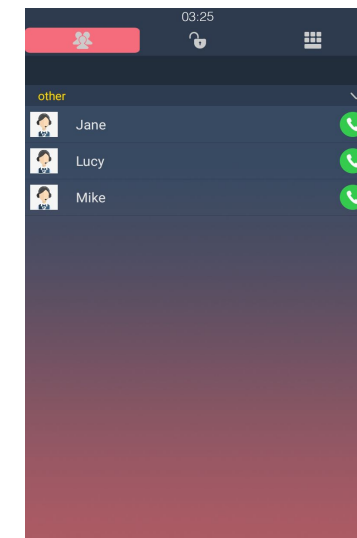

Figure 2.1.2 Contact interface

2.2. Receive a Call

When a monitor unit calls the door phone, it will auto answer the incoming call by default. There is no need to press any answer key.

2.3. Unlock

2.3.1. Unlock by Pin Codes

Unlock the door by using predefined public pin or private pin. Press **“Pin Code”**, **“Unlock”** icon to unlock, then you will hear “The door is now opened” and the screen will show “Open Lock Success”. If users input the wrong pin code, the screen will show “Password Error”.

2.3.2. Unlock by Face

Unlock the door by using predefined face. Enter the unlock interface, close your face to the camera. You will hear “the door is

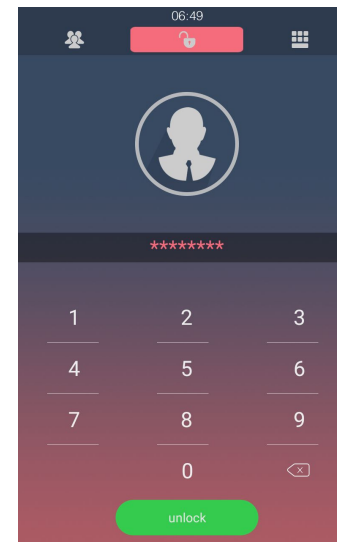

Figure 2.3.1 Unlock by pin code

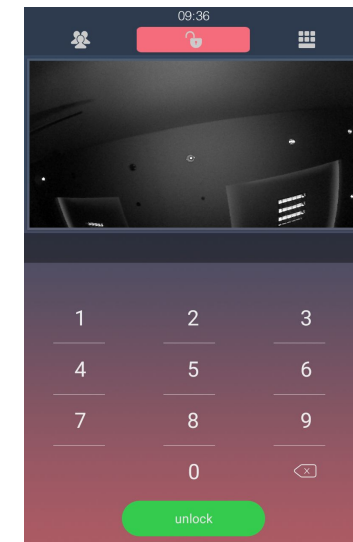

Figure 2.3.2 Unlock by face

opened” and screen will show “Open Lock Success”.

2.3.3. Unlock by RFID cards

Place the predefined users card in RFID cards reader to unlock. Under normal conditions, the phone will announce “The door is now opened” and the screen will show “Open Lock Success”. If the card has not been registered, the phone will show “Open Lock Failed”.

2.3.4. Unlock by DTMF codes

During the calling, the president can press the predefined DTMF codes to remote unlock the door.

3. Basic Features

3.1. Access the system setting

In the Dial interface, press “9999”, “Dial key”, “3888”, “OK” to enter the system setting. System setting is easy to configure most basic phone functions.

3.2. Access the website setting

3.2.1. Obtain IP Address

R29 series use DHCP IP by default. Enter the phone interface and go to **Info** to check the IP address.

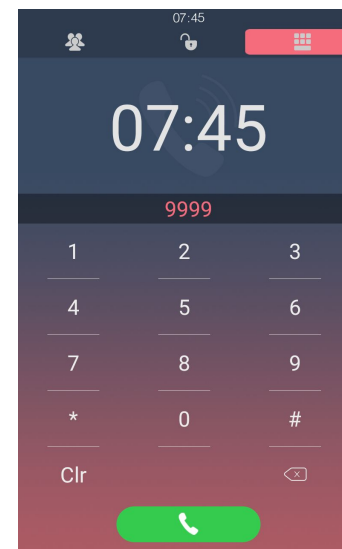

Figure 3.1-1 Access the system setting

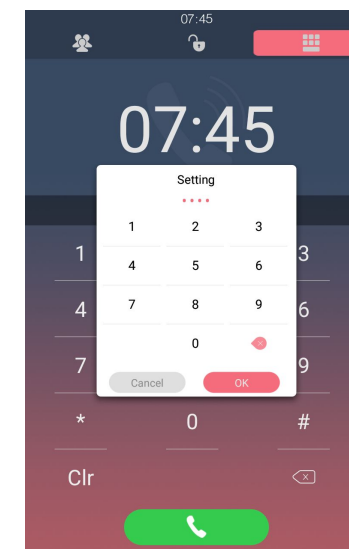

Figure 3.1-2 Access the system setting

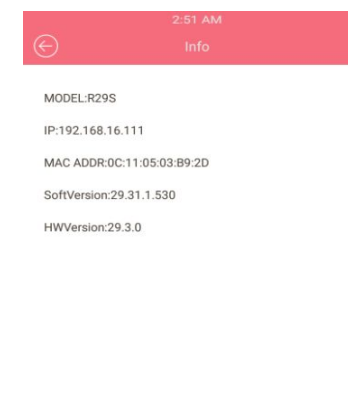

Figure 3.2.1 Info

3.2.2. Access the Device Website

Open a web browser, and access the corresponding IP address. Enter the default user name and password to login. The default administrator's user name and password are shown below:

User Name: **admin**

Password: **admin**

Note: The recommended browser is Google Chrome.

3.3. Password Modification

3.3.1. Modify the Phone System Password

Users can configure project key with this function. The public key is a password used by all occupants in a building. Project key is used by administrators for some basic settings. There are two ways to change the system password, which can be done on the phone system and on the intercom website.

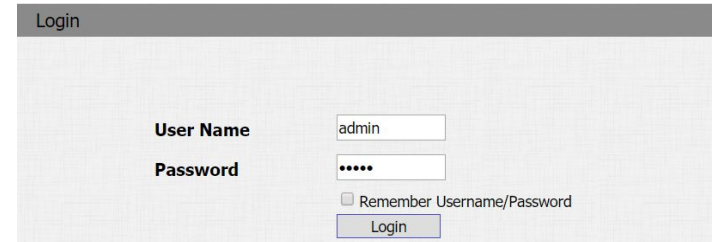

Figure 3.2.2 Access the device website

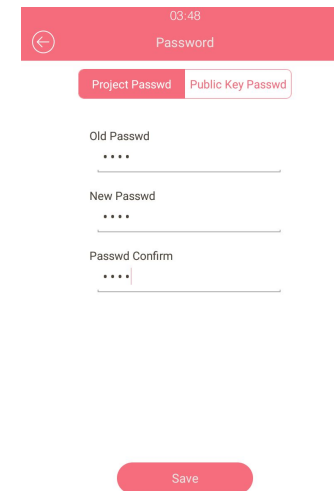

Figure 3.3.1-1 Modify the system password

In the phone interface, go to the **Password - Project Passwd** to change the project key passwd.

Project Passwd: Enter the 4 digits old project key, the default project key is “9999”. Then enter the 4 digits new passwd, after entering the new passwd confirm, click **save** icon .

In the website, go to the path **Intercom - Basic - Password** to configure.

3.3.2. Modify the Web Password

Login to the website and go to the path **Security - Basic**, to modify password for “admin” or “user” account.

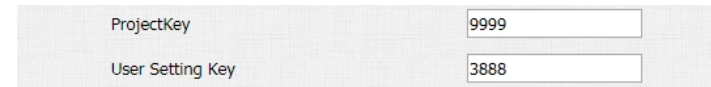

The screenshot shows a form with two input fields. The first field is labeled "ProjectKey" and contains the value "9999". The second field is labeled "User Setting Key" and contains the value "3888".

Figure 3.3.1-2 Modify the system password

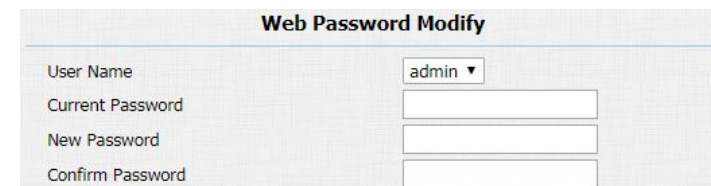

The screenshot shows a form titled "Web Password Modify". It has four input fields: "User Name" with a dropdown menu showing "admin", "Current Password", "New Password", and "Confirm Password".

Figure 3.3.2 Modify the web password

3.4. Phone configuration

3.4.1. Language

3.4.1.1. Modify the phone language

In the phone interface, go to **Language** to configure. Now R29 series can support multiple phone language. Users can choose manually. Akuvox uses English by default.

3.4.1.2. Modify the web language

Enter the intercom website and go to the path **Phone - Time/lang - Web Language** to configure. Now R29 series can support multiple web language. Users can choose manually. Akuvox uses English by default.

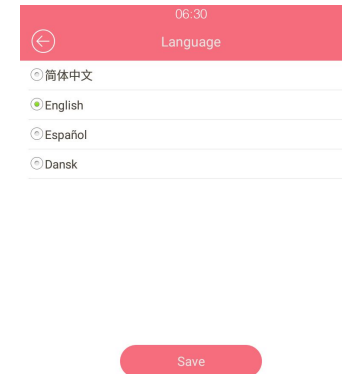

Figure 3.4.1.1 Configure phone language

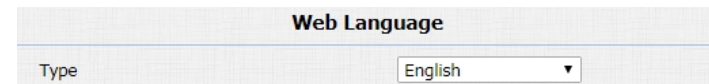

Figure 3.4.1.2 Configure Web Language

3.4.2. Time

In the phone interface, go to **Time** to configure. Choose automatic date & time setting for automatic access of time, date and time zone. Or set the time, date and time zone manually.

3.4.3. Network

In the phone interface, go to **Address** or login to the website and go to the path **Network - Basic**, dynamically or statically to obtain address.

3.4.3.1. DHCP Mode

R29 series uses DHCP mode by default which will get IP address, subnet mask, default gateway and DNS server address from DHCP server automatically.

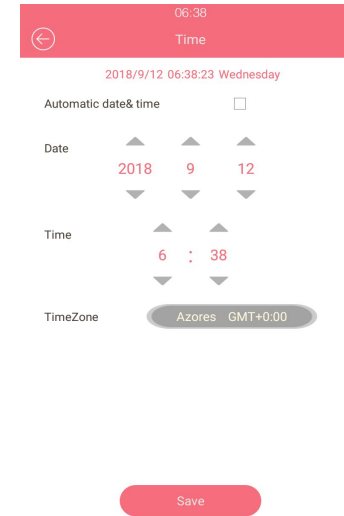

Figure 3.4.2 Time

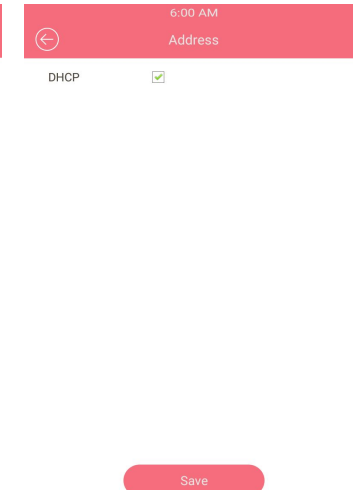

Figure 3.4.3.1-1 DHCP mode

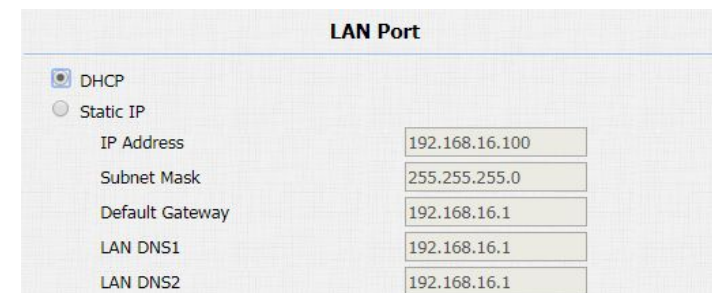
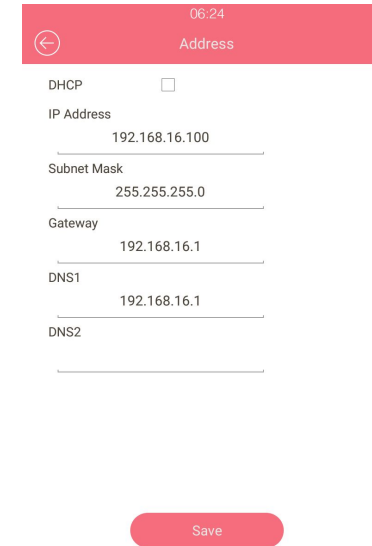

Figure 3.4.3.1-2 DHCP mode

3.4.3.2. Static Mode

If select static IP, users should manually setup IP address, subnet mask, default gateway and DNS server address. The figure right shows static IP setting.



A mobile interface for configuring network settings. At the top, there is a red header bar with a back arrow on the left, the time '06:24' on the right, and the title 'Address' in the center. Below the header, there is a 'DHCP' option with an unchecked checkbox. Underneath, several input fields are shown: 'IP Address' with the value '192.168.16.100', 'Subnet Mask' with '255.255.255.0', 'Gateway' with '192.168.16.1', 'DNS1' with '192.168.16.1', and 'DNS2' which is empty. At the bottom of the screen, there is a red 'Save' button.

Figure 3.4.3.2-1 Static mode

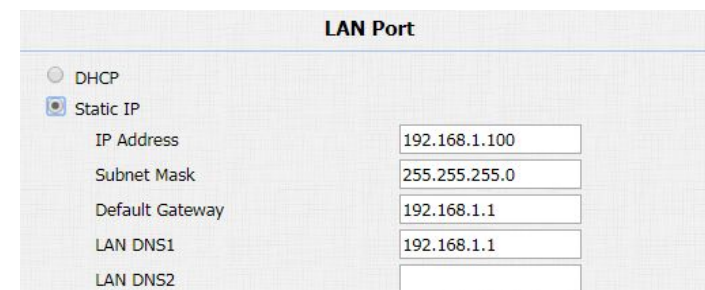

A web interface titled 'LAN Port'. It features two radio buttons: 'DHCP' (unselected) and 'Static IP' (selected). Below these are several input fields: 'IP Address' (192.168.1.100), 'Subnet Mask' (255.255.255.0), 'Default Gateway' (192.168.1.1), 'LAN DNS1' (192.168.1.1), and 'LAN DNS2' (empty).

Figure 3.4.3.2-2 Static mode

3.4.4. Display

3.4.4.1. Await

In the phone interface, go to **Await** or login to the website and go to the path **Intercom - Advanced - StandBy**, to set the standby mode, standby time and unlock mode.

Standby Mode: There are three options for the standby mode. 'NO' mode is for the door phone's default dial interface to remain permanently on; "Blank" mode screen is a black screen during standby; and "Picture" mode is a chosen screensaver of your like, which can be imported in bulk by the administrator.

Standby Time: Users can set the standby time from 30 Sec to 180 Sec.

Unlocked Mode: To choose how to wake up the door phone from the standby mode.

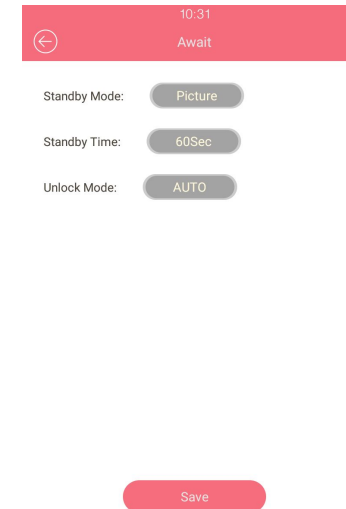

Figure 3.4.4.1-1 Await



Figure 3.4.4.1-2 StandBy

3.4.4.2. Upload ScreenSaver

In the website and go to the path **Phone - Import/Export - Upload screensaver** to configure. To upload screen saver and set the corresponding interval time and the priority. It will be displayed on screen when R29 series stand by type as picture. Up to 5 different screen savers can be supported. These pictures will scroll to display. The format must be .jpg. If the interval time is 0, it won't be displayed.

If users need to upload many pictures, please choose the ID order of the picture. For example, users need to upload the first picture as ID 1 which will be first screensaver to display, users will choose Image 1. Then users will upload the second one, users need to choose Image 2 and so on.

Screensaver1: To choose the favorite image, and upload it (the most suitable image size is 1280*800).

After uploading, the pictures will be in the list. Then users need to

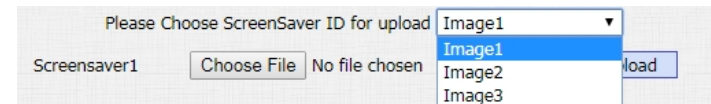

Figure 3.4.4.2-1 Upload ScreenSaver

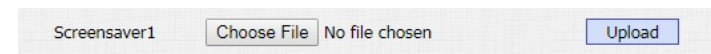

Figure 3.4.4.2-2 Upload ScreenSaver

manually setup the Interval time which means how long the image will display then change to next screensaver. Interval range from 0 to 120s. Click the **Submit** to save each one. Click **Delete** to remove the picture.

3.4.4.3. Door Setting General

In the website and go to the path **Intercom - Basic - Door Setting General** to configure.

Display Type: Setup the home page's default display interface. There are four types can be choice "Dial", "Contact", "Only-Contact", "Password".

Number of Show Contacts: Users can setup 0 to 8 top contacts under only -contact mode. The top contacts are some important or commonly used numbers.

DialPad Input Number Limit: To limit the input numbers to prevent unnecessary security problems.

Upload ScreenSaver (.jpg)				
ID	File Status	Interval	Submit	Delete
1	File Exists	3	Submit	Delete
2	File Exists	3	Submit	Delete
3	NULL	0	Submit	Delete

Figure 3.4.4.2-3 Upload ScreenSaver

Display Type	<div style="border: 1px solid black; padding: 2px;"> Password ▼ Dial Contact Only-Contact Password </div>
RTP TimeOut	
Number of Show Contacts	

Figure 3.4.4.3-1 Display type

Number of Show Contacts	<input type="text" value="4"/>
-------------------------	--------------------------------

Figure 3.4.4.3-2 Number of show contacts

DialPad Input Number Limit	<input type="text" value="Default"/>
----------------------------	--------------------------------------

Figure 3.4.4.3-3 Dialpad input number limit

3.4.4.4. Home View Visible Control

In the website and go to the path **Intercom - Basic - How View Visible Control** to configure.

Users can setup whether the home page-dial interface, contact interface, unlock interface is visible. For example, if users enable dialview, users will only see dialing interface , the other two will be hidden.

3.4.5. Volume

In the phone interface, go to **Volume**, to configure the call volume, AD volume and key volume.

Call Volume: When R29 series dials out a call, it will prompt the 'du' sound. To configure the call volume by yourself.

AD Volume: When the door is opened, the phone will announce the opendoor tone. To configure the AD volume by yourself.

Key Volume: When touch the screen, that will be a prompt

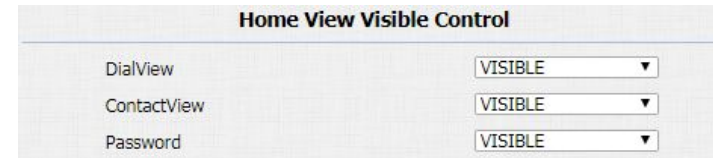

Figure 3.4.4.4 How view visible control

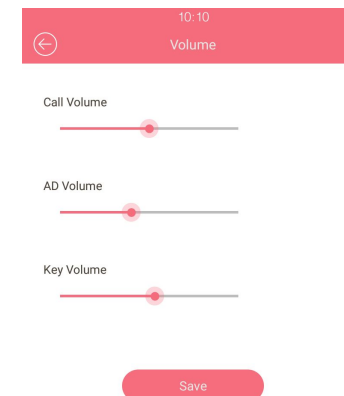

Figure 3.4.5-1 Phone volume

sound. To configure the key volume by yourself.

Also users can modify the other voice settings in the website.

Call Volume: Login to the website and go to the path **Phone - Call Feature - Others** to show the volume adjustment in talking interface.

Mic Volume: Login to the website and go to the path **Phone - Voice**, to configure Mic volume.

Login to the website and go to the path **Intercom - Advanced - Open Door Warning** to configure.

Open Door Warning: Disable it, users will not hear the prompt voice when the door is opened.

Open Door Tone: Login to the website and go to the path **Phone - Import/Export - Open Door Tone** to upload the Opendoor tone by



Figure 3.4.5-2 Call volume

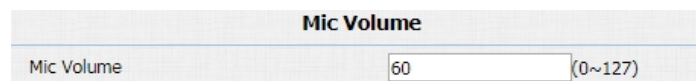

Figure 3.4.5-3 Mic volume



Figure 3.4.5-4 Open door warning

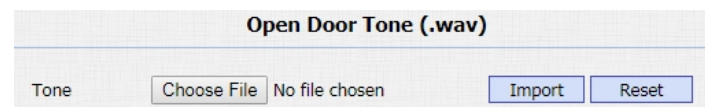

Figure 3.4.5-5 Upload the open the door tone

yourself.

Open Door Tone: Users can also go to the path **Intercom - Door Setting General** to configure the switch whether users will hear the “the door is opened” announcement.

3.4.6. DND

DND allows IP phones to ignore any incoming calls. Users can login to the website and go to **Phone - Call Feature** to configure.

Return Code when DND: Determine what response code should be sent back to server when there is an incoming call if DND on.

DND On Code: The code used to turn on DND on server’s side, if configured, IP phone will send a SIP message to server to turn on DND on server side if user press DND when DND is off.

DND Off Code: The code used to turn off DND on server’s side, if configured, IP phone will send a SIP message to server to turn off DND on server side if user press DND when DND is on.



Figure 3.4.5-6 Open door tone switch

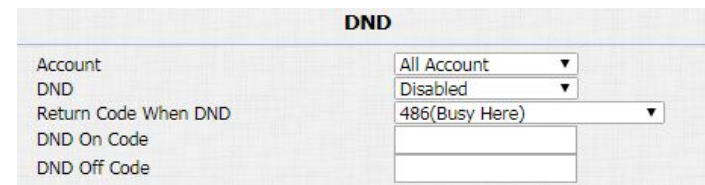



Figure 3.4.6 DND

3.5. Phonebook

In the phone interface, go to **Contact** to configure the phonebook.

Create a group: Choose group, click **Add** to enter the new group name. Press  to save.

Edit a group: Choose the existed group to modify or delete.

Create a contact: Click **Add** to enter the contact's information. Choose a suitable Group and contact's name and Phone number, press  to save.

Edit a contact: Choose a exist contact to edit or delete it.

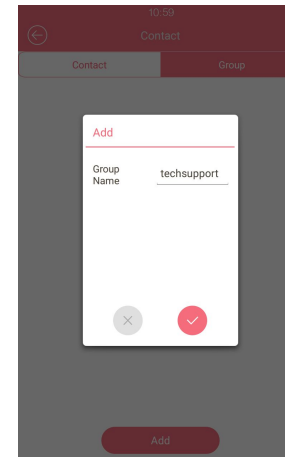

Figure 3.5-1 Adding group

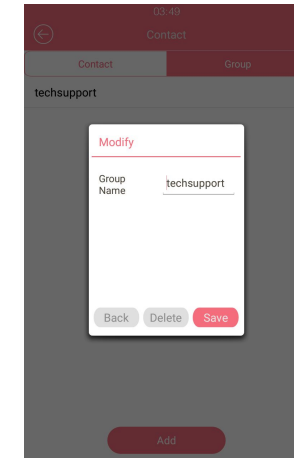

Figure 3.5-2 Editing group

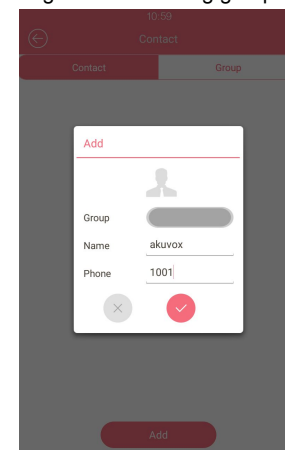

Figure 3.5-3 Adding contact

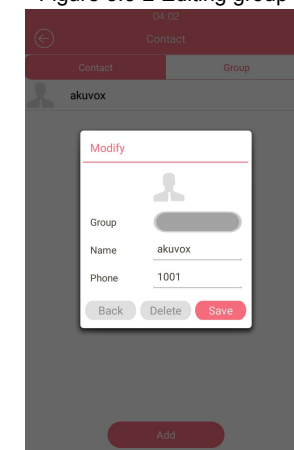

Figure 3.5-4 Editing contact

In the website, go to the path **Phonebook - Local Book** to configure the phonebook.

Contact: To display or edit all local contacts.

Search: Enter the key word to search designated contacts from local phonebook.

Contact Setting: Choose a suitable contact picture, then import (optional); Enter the corresponding contact name and phone number; Click **Add** to save.

Note: The photo only supports .png format.

Group: To check all group in the list or choose one to delete.

Group Setting: Enter the new group name, click **Submit** to save;

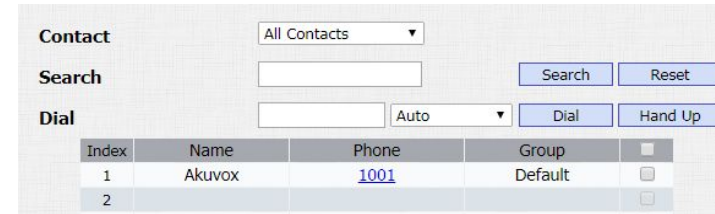

Figure 3.5-5 Phonebook

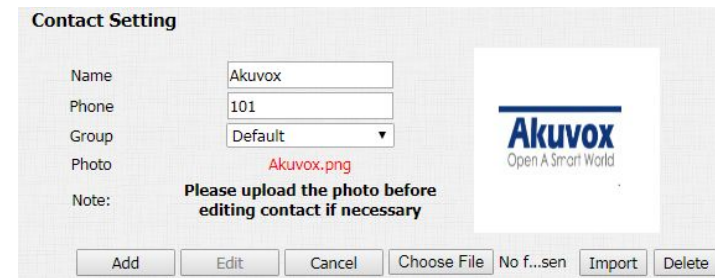

Figure 3.5-6 Contact setting

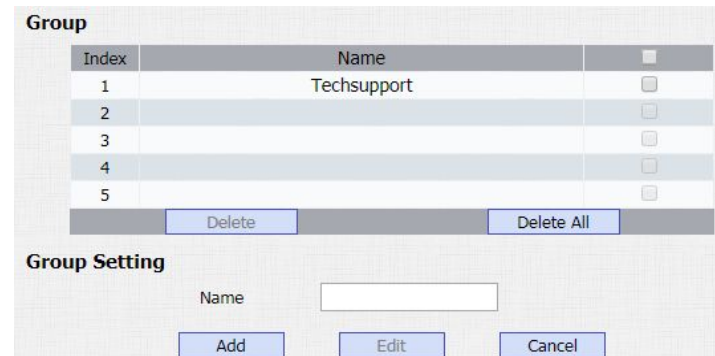

Figure 3.5-7 Group configure

Users can also login to the website and go to the path **Phone - Import/Export - Import/Export Config&Contacts** to upload or download the contact information.

Contact: Click **Export** to export the existed contact. Choose the local file and click **Import** to import the new contact. The export format is .vcf, the import format is .vcf, .csv or .xml. The import maximum is 3000.

Login to the website and go to the path **Intercom - Basic - Door Setting General** to configure item touch and contact profile picture function.

Item Touch: This function is convenient for users to press anywhere in the contact line to call out, don't have to call out to touch the call button.

Contact Profile Picture: To setup whether it will show contact picture or not.

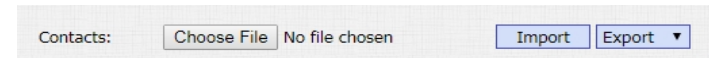

Figure 3.5-8 Import/Export contacts



Figure 3.5-9 Contact display

3.6. Intercom call

3.6.1. IP Direct Call

In the dial interface. Enter the number to call on the digital keypad, and tap the dial icon. Without SIP server, users can also use IP address to call each other. However, this way is only suitable in the LAN. Enter the IP address of the callee, and press the **dial** icon.

Login to the website and go to the path **Phone - Call Feature - Others** to configure the call related features.

Direct IP: To call someone with dialing IP address directly.

Direct IP Port: To configure the direct IP port.

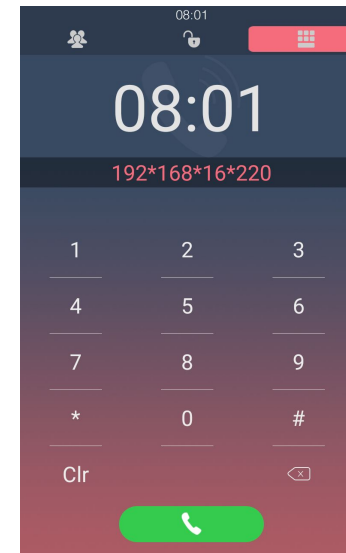

Figure 3.6.1-1 Dial interface



Figure 3.6.1-2 Direct IP

3.6.2. SIP Call

SIP call uses SIP number to call each other which should be supported by SIP server. Users need to register an account and fill some SIP feature parameters before using SIP call.

Login to the website and go to the path **Account - Basic** to configure SIP account and SIP server for door phone first.

3.6.2.1. Account

R29 series supports 2 accounts. According to your needs, register one or two accounts and users can switch them by themselves.

Enter the system setting interface, choose account. According to the configuration of PBX, enter the account parameters. Tick enable to active the account. If you register 2 accounts in the same time. R29 series will choose the account 1 as the default account.

3.6.2.2. SIP Account

In the phone interface, go to **Account - Account setting - Account 1&2** to configure the SIP account.

Enable Account: SIP account is only available if you enable this account.

Register Name: To enter extension number you want and the number is allocated by SIP server.

User Name: To enter user name of the extension.

Password: To enter password for the extension.

Display Name: To configure name sent to the other call party for displaying.

Note: After configurations, users can go to the **website - Account - Basic - SIP Account** to check the register status.



Figure 3.6.2.2-1 SIP account

Login to the website and go to the path **Account - Basic - SIP Account** to configure the SIP account.

Status: To display register result.

Account: Select the SIP account you need to configure.

Account Active: SIP account is only available if users enable this account.

Display Label: To configure label displayed on the phone's LCD screen.

Display Name: To configure name sent to the other call party for displaying.

Register Name: To enter extension number users want and the number is allocated by SIP server.

User Name: To enter user name of the extension.

Password: To enter password for the extension.

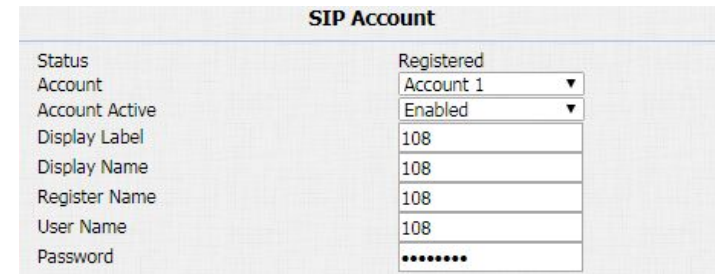

SIP Account	
Status	Registered
Account	Account 1
Account Active	Enabled
Display Label	108
Display Name	108
Register Name	108
User Name	108
Password	••••••••

Figure 3.6.2.2-2 SIP account

3.6.2.3. SIP Server

In the phone interface, go to **Account - Account setting - Account 1&2** to configure the SIP server. Users can also go to the path **Account - Basic - SIP Server 1&2** to configure.

Server IP: To enter SIP server's IP address or URL.

Server Port: To enter the SIP server port.

Registration Period: The registration will expire after registration period, the IP phone will re-register automatically within registration period.

3.6.2.4. Outbound Proxy Server

Login to the website and go to the path **Account - Basic - Outbound Proxy Server** to display and configure outbound proxy server settings. An outbound proxy server is used to receive all initiating request messages and route them to the designated SIP server.

Reg Server IP 192.168.10.27
Reg Server Port 5060
Save

Figure 3.6.2.3-1 SIP server

SIP Server 1
Server IP 192.168.10.27 Port 5060
Registration Period 1800 (30~65535s)

Figure 3.6.2.3-2 SIP server

Outbound Proxy Server
Enable Outbound Disabled
Server IP
Backup Server IP Port 5060
Port 5060

Figure 3.6.2.4 Outbound proxy server

3.6.2.5. Transport Type

To display and configure transport type for SIP message

UDP: UDP is an unreliable but very efficient transport layer protocol.

TCP: Reliable but less-efficient transport layer protocol.

TLS: Secured and Reliable transport layer protocol.

DNS-SRV: DNS record for specifying the location of services.

3.6.3. Dial Plan

● Replace Rule

Replace rule is using some simple number or symbol to replace a complicated phone number or IP address. It is more suitable for some one who want to hide the real phone number or simplify the long number. This is more convenient for users.

In the phone system, go to **Replace Rule**, click **Add**, choose a suitable account and enter the value, press **OK** to confirm. It

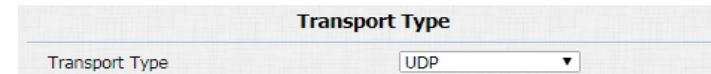

Figure 3.6.2.5 Transport type

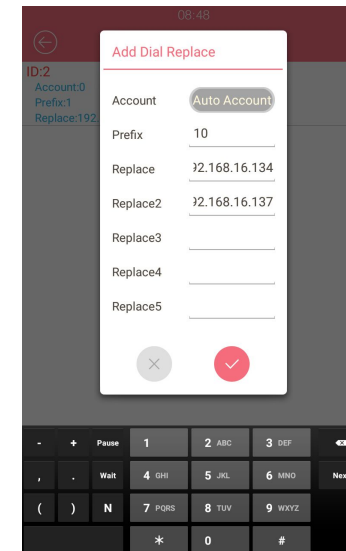

Figure 3.6.3-1 Replace rule

supports a prefix number replace 5 number at the same time, when the user press the prefix number, the 5 devices will ring at the same time.

For example:

Users can pre-configure 10 to replace 192.168.16.134 and 192.168.16.137 in the doorphone. Then, by pressing 10, the two devices can be dialed at the same time through the default account without having to remember the long phone number or dial separately.

Users can also login to the website and go to the path **Phone - Dial Plan** to configure this function. R29 allows users to modify replace rule in the website.

All replace rules will show in the list. Users can edit or delete the existed replace rules.

Rules Modify >>

Account	Auto
Prefix	1
Replace 1	192.168.16.187
Replace 2	192.168.16.134
Replace 3	
Replace 4	
Replace 5	

Submit Cancel

Figure 3.6.3-2 Dial plan

Rules Replace Rule

Index	Account	Prefix	Replace 1	Replace 2	Replace 3	Replace 4	Replace 5
1	Auto	1	192.168.16.187	192.168.16.134			
2							

Figure 3.6.3-3 Dial plan

3.6.4. Quick Dial

Quick Dial is to call predefined important number quickly in main interface. This number is often set as emergency number.

In the phone interface, go to **Quick Dial**, switch the type as quick dial, enter the quick dial name and number, click **Save** to confirm.

3.6.5. Auto Answer

Login to the website and go to the path **Account - Advanced - Call - Auto Answer** to enable the auto answer.

Login to the website and go to the path **Phone - Call Feature - Others** to configure the auto answer related function.

Return Code When Refuse: Allow users to assign specific code as return code to SIP server when an incoming call is rejected.

Auto Answer Mode: To choose video or audio mode for auto answer.

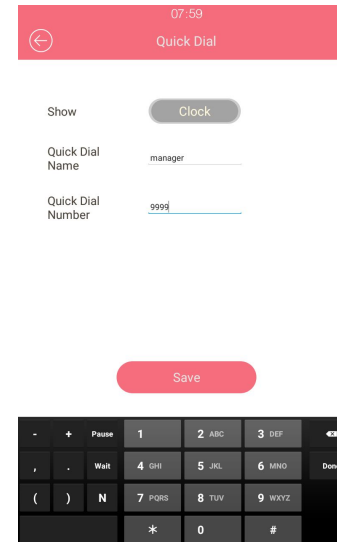

Figure 3.6.4-1 Quick dial configure

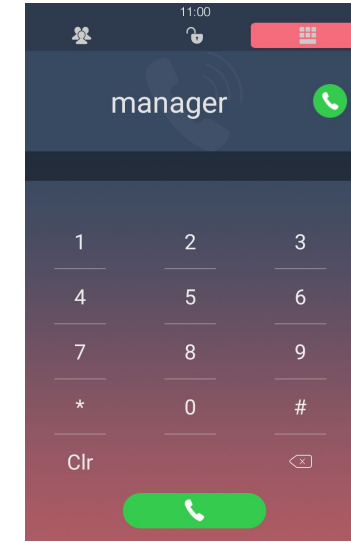

Figure 3.6.4-2 Quick dial



Figure 3.6.5 -1 Auto answer



Figure 3.6.5 -2 Auto answer

Auto Answer Delay: To configure delay time before an incoming call is automatically answered.

3.6.6. No Answer Call

This feature is used to transfer the call to the target number in order if the calling is no answered with timeout. Login to the website and go to the path **Phone - Call Feature - No Answer Call** to configure.

To setup two no answer call number. They will be called by order.

3.6.7. Web Call

Login to the website and go to the path **Phonebook - Local Book - Dial** to dial out from website.

Dial: To dial out a call or hangup an ongoing call from website.

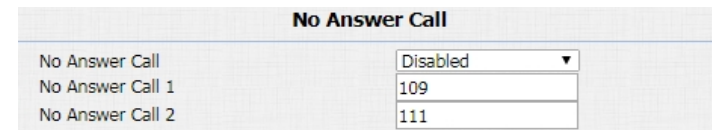

No Answer Call	
No Answer Call	Disabled
No Answer Call 1	109
No Answer Call 2	111

Figure 4.2.4 No answer call



Dial		Auto	Dial	Hand Up
------	--	------	------	---------

Figure 3.6.6 Web call

3.7. Security

3.7.1. Mjpeg Service

Login to the website and go to the path **Intercom - Advanced - Mjpeg Server** to configure.

Mjpeg Service Enable: Use to capture from the URL. It is convenient to check the capture remotely.

Image Quality: To choose the image quality of the capture.

Picture URL:

http:// device ip:8080/picture.cgi

http://device ip:8080/picture.jpg

http://device ip:8080/jpeg.cgi

3.7.2. Live Stream

Login to the website and go to the path **Intercom - Live Stream**, check the real-time video from R29. In addition, users can also

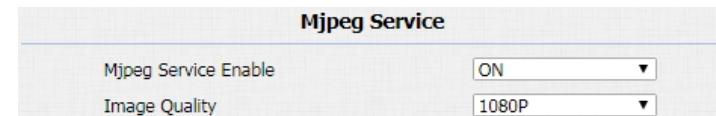

Figure 3.7.1 Mjpeg service

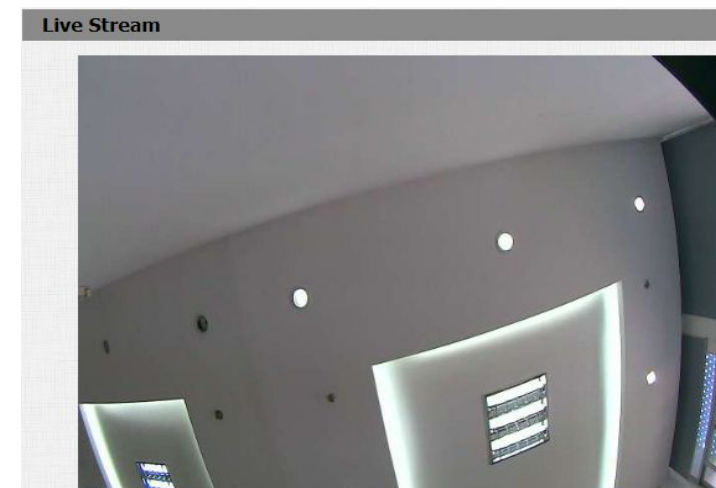

Figure 3.7.2 Live view

check the real-time picture via URL:

http://IP_address:8080/picture.

3.7.3. RTSP

- **RTSP Basic**

R29 series support RTSP stream, enter the phone system, go to **RTSP** or login to the website and go to the path **Intercom - RTSP**, to enable or disable RTSP server. The URL for RTSP stream is:

rtsp://IP_address/live/ch00_0

- **H.264 Video Parameters**

H.264 is a video stream compression standard. Different from H.263, it provides an approximately identical level of video stream quality but a half bit rate. This type of compression is sometimes called MPEG-4 part 10. To modify the resolution, framerate and bitrate of H.264.

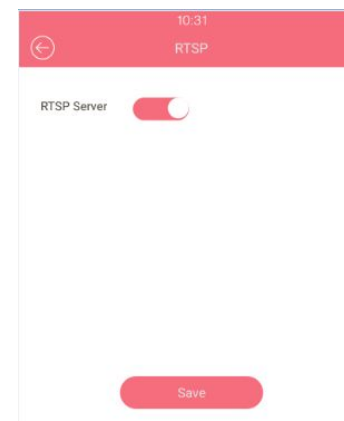

Figure 3.7.3-1 RTSP

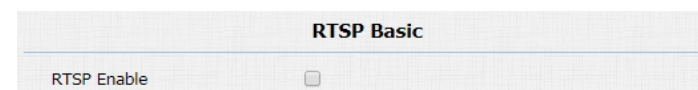

Figure 3.7.3-2 RTSP

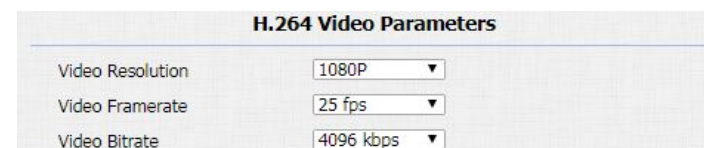

Figure 3.7.3-3 H.264 video parameters

3.7.4. ONVIF

R29 series supports ONVIF protocol, which means R29 series camera can be searched by other devices, like NVR, which supports ONVIF protocol as well. Go to the path **Intercom - ONVIF** on the web GUI, to configure ONVIF mode and its username/password.

Switching ONVIF mode to “undiscoverable” means that Users must program ONVIF’s URL manually.

The ONVIF’s URL is:

http://IP_address:8090/onvif/device_service

3.8. Access Control

3.8.1. Relay

Login to the website and go to the path **Intercom - Relay** to configure.

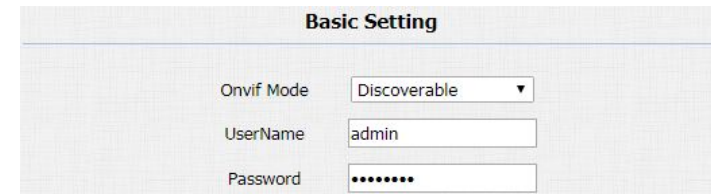

The screenshot shows a web interface titled "Basic Setting". It contains three configuration fields: "Onvif Mode" with a dropdown menu set to "Discoverable", "UserName" with a text input field containing "admin", and "Password" with a masked text input field showing seven dots.

Figure 3.7.4 ONVIF setting

Relay ID: R29 series supports three relays. Users can configure them respectively.

Trigger Delay: To configure the duration of the trigger relay. With the trigger condition, the relay will only be triggered if the value is reached.

Hold Delay: To configure the duration of opened relay. Over the value, the relay would be closed again.

DTMF Option: To select digit of DTMF code, R29 series supports maximum 4 digits DTMF code.

DTMF: To configure 1 digit DTMF code for remote unlock

Multiple DTMF: To configure multiple digits DTMF code for remote unlock.

Relay Status: While the relay is triggered, the status will be switched. When COM connects to NC, the status is Low.

Note: Relay operate a switch and does not deliver power, so users should prepare power adapter for external devices which connects to relay.

Relay			
Relay ID	RelayA	RelayB	RelayC
Trigger Delay(sec)	0	0	0
Hold Delay(sec)	5	5	5
DTMF Option	1 Digit DTMF		
DTMF	0	1	2
Multiple DTMF	010	012	013
Relay Status	RelayA: Low	RelayB: Low	RelayC: Low

Figure 3.8.1 Relay

3.8.2. Unlock via RFID Cards

3.8.2.1. RFID Cards in Devices

R29 series can be compatible with 13.56MHZ and 125KHZ RFID cards.

Add

Press “**Add Card**”, when you see “Please scan the RFCard to Add”, put the card near the card sensor. Then enter the card name , valid day and time in the modify prompt. Click **OK** to save.

Modify

Press “**Del Card**”, when you see “Please scan RFCard to Delete”, put the existed card near the card sensor, click **Del** to delete in the modify prompt. Or users can just choose the existed card from the list, delect directly.

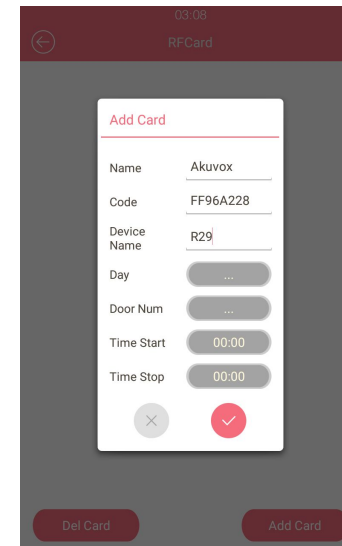

Figure 3.8.2-1 RFID key

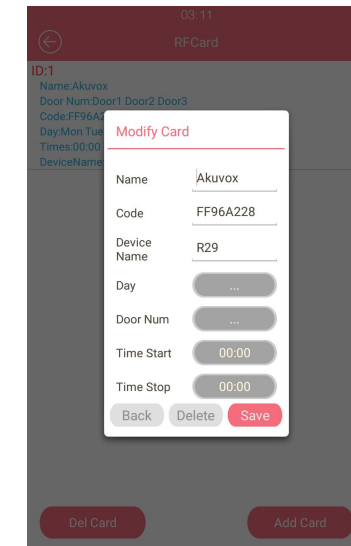

Figure 3.8.2-2 RFID key

3.8.2.2. RFID Cards in Website

Go to the path **Intercom - Card setting**, to manage RFID cards access system.

Import/Export Card Data: Export the existed RFID cards information or import the new RFID cards information. It can only support .xml format. The maximum is 1000.

Note: Ask your administrator for the card data template if you need.

Obtain and Add Card:

- (1) Switch card status to “Card Issuing” and click “**Apply**”;
- (2) Place card on the card reader area and click “**Obtain**”;
- (3) Name card and choose which door you want to open and the valid day and time;
- (4) Click “**Add**” to add it into list.

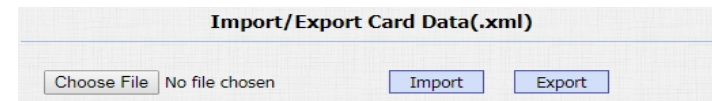

Figure 3.8.2-3 Import/Export card data

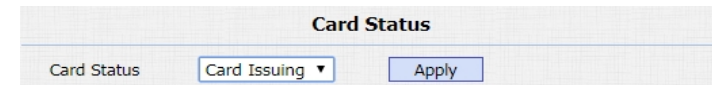

Figure 3.8.2-4 Card status

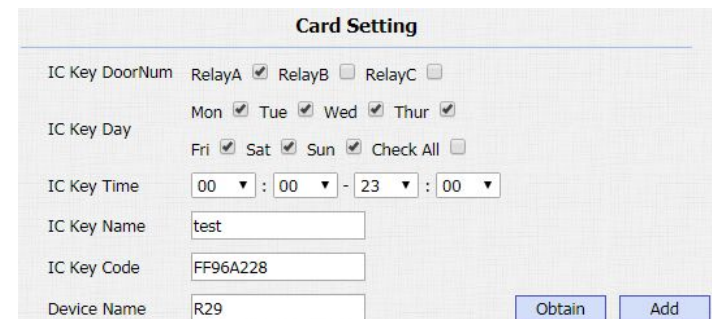

Figure 3.8.2-5 Card setting

Door Card Management:

Valid card information will be shown in the list. Administrator could delete one card's access permission or empty all the list.

Note: Remember to set card status back to normal after adding the cards.

3.8.3. Unlock via Pin Codes

3.8.3.1. Private Pin Codes in Device

In the phone interface, go to **LockPasswd**, enter the owner name, 8 digits private keys and Device (optional). Setup the valid day and time for the password.

For example:

Owner name is Eve, private key is 12345678, and I set up the valid day from Mon to Sun, click  to save.

Door Card Management					
Index	Name	Code	Relay	Device Name	
1	test	FF96A228	1	R29	<input type="checkbox"/>
2	test1	00645C0E	1		<input type="checkbox"/>
3					<input type="checkbox"/>
4					<input type="checkbox"/>

Figure 3.8.2-6 Door card management

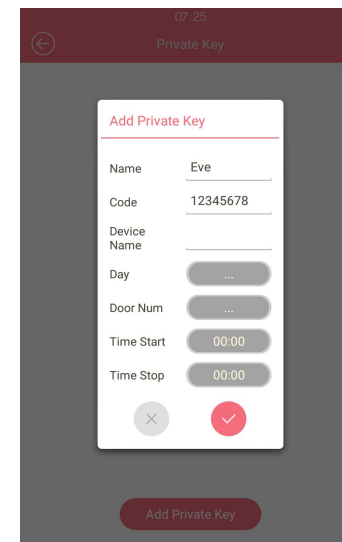

Figure 3.8.3.1-1 Adding private key

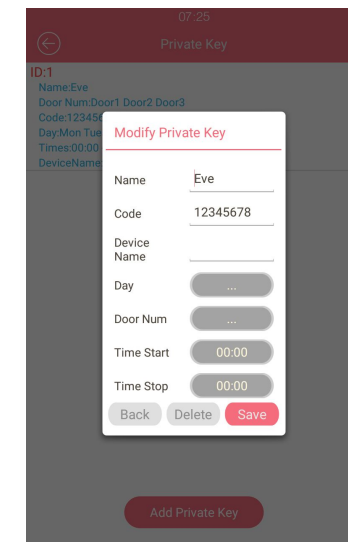

Figure 3.8.3.1-2 Editing private key

3.8.3.2. Private Pin Codes in Website

Go to the path **Intercom - Privatekey** on the web GUI, to manage RFID cards access system.

Import/Export Private Key: Export the existed private key information or import the private key from local side. It can only support .xml format. The maximum private key is 1000.

Obtain and Add Code:

- (1) Enter the “PKey Name” and “PKey Code”;
- (2) Select the valid day and time;
- (3) Choose which door users want to open;
- (4) Click “**Add**” to add it into list.

Private Key Management:

Valid private key information will be shown in the list. Administrator could delete private key information or empty all the list.

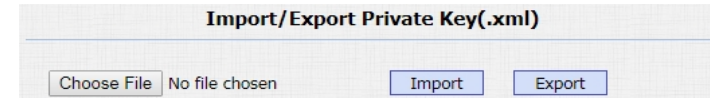

The screenshot shows a web interface titled "Import/Export Private Key(.xml)". It contains a "Choose File" button, a status message "No file chosen", and two buttons labeled "Import" and "Export".

Figure 3.8.3.2-1 Import/Export private key

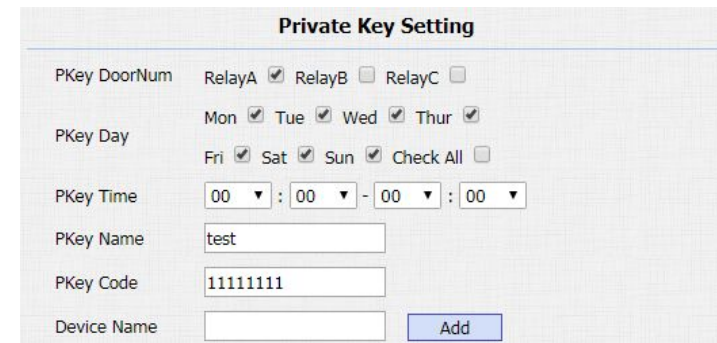

The screenshot shows a "Private Key Setting" form. It includes the following fields and options:

- PKey DoorNum: RelayA , RelayB , RelayC
- PKey Day: Mon , Tue , Wed , Thur , Fri , Sat , Sun , Check All
- PKey Time: 00 : 00 - 00 : 00
- PKey Name: test
- PKey Code: 11111111
- Device Name: [empty field]
- Buttons: Add

Figure 3.8.3.2-2 Private key setting



Index	Name	Code	Relay	Device Name	
1	Eve	12345678	123		<input type="checkbox"/>
2	test	11111111	1		<input type="checkbox"/>
3					<input type="checkbox"/>
4					<input type="checkbox"/>

Figure 3.8.3.2-3 Private key management

3.8.3.3. Public Pin Codes in device

In the phone interface, go to **Password - Public Key Passwd**, enter the old public key, R29 series support 3 default public keys. Then enter the new passwd, after entering the new passwd Confirm, click **save** icon.

Note: Just need to enable public key passwd in public key passwd setting.

3.8.3.4. Public Pin Codes in websites

Go to the path **Intercom - Basic - Password**. Users can configure project key and public key with this function. Public key is the password used by all occupants in a building.

Public Enable: The default status is on.

PublicKey Bits Limit: Setup the key digits.

Public Key: R29 series support 3 default public keys, users can reset a new public key.

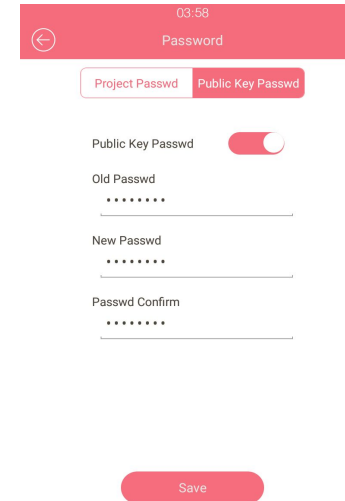

The image shows a mobile application interface for setting a public key password. At the top, there is a red header with the time '03:58' and the title 'Password'. Below the header, there are two tabs: 'Project Passwd' and 'Public Key Passwd'. The 'Public Key Passwd' tab is selected. Underneath, there is a toggle switch for 'Public Key Passwd' which is turned on. Below the toggle, there are three input fields: 'Old Passwd', 'New Passwd', and 'Passwd Confirm', each containing a series of dots representing masked characters. At the bottom of the screen, there is a red 'Save' button.

Figure 3.8.3.3 Public key



The image shows a web interface for configuring password settings. The title is 'Password'. There are four rows of settings:

Setting	Value
PublicKey Enable	ON
PublicKey Bits Limit	Default(8 Bits)
PublicKey_0	33333333
PublicKey_1	66666666
PublicKey_2	88888888

Figure 3.8.3.4 Password

3.8.4. Unlock via Face

3.8.4.1. Face in Device

In the phone interface, go to **Face** to record the Face ID.

Add:

Close your face to the camera, in the middle of the round box on the screen. If a face is recognized, the face ID will be automatically admitted. Click “**Confirm**” after the recognition is completed, then enter the face registration name and click “**Register**” to save the face ID.

Modify:

Click **Face database**, choose the existed database to delete.

3.8.4.2. Face in Website

Go to the path **Intercom - Face** on the web GUI to configure the face information.

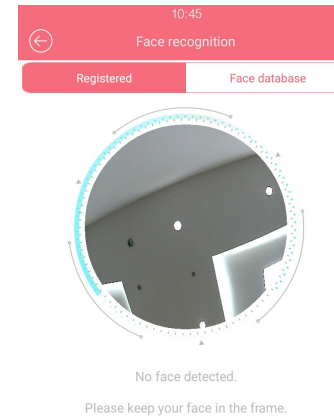

Figure 3.8.4.1.1 Face recognition

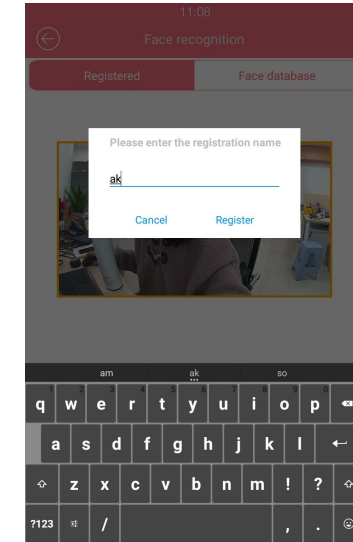

Figure 3.8.4.2.2 Face recognition

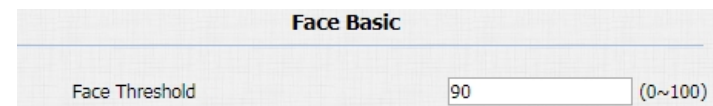

Figure 3.8.4.2-1 Face basic

Face Threshold: Smaller the value, lower the face accuracy.

Search: Enter key word to quick search. Check the existed face data from the list.

Face Data: Support to import or export the face data. The export format is .tgz, the import format is .zip.

Import/Export file: Because R29 series can not support the third party camera to enter the face picture now. Users need to directly take face data in the R29 series, then export the existed face file. It is convenient to share the same face data in multiple devices.

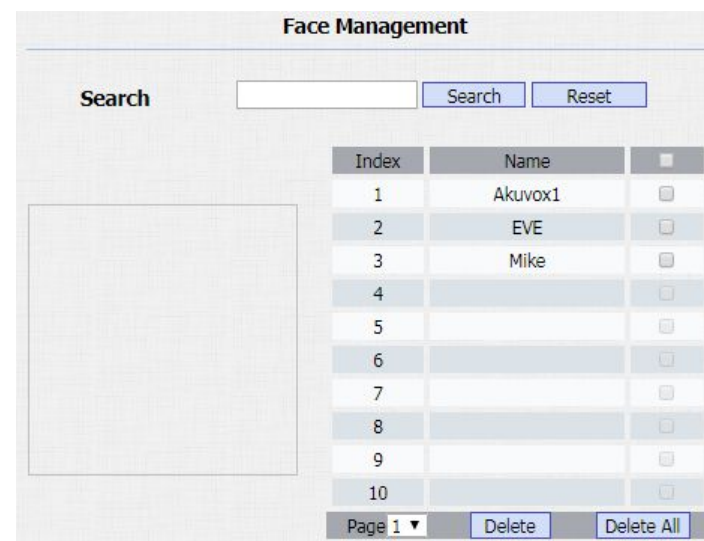

Figure 3.8.4.2-2 Face Management

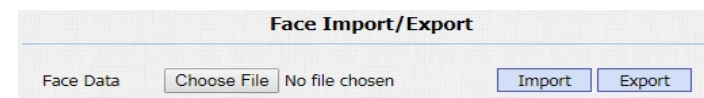

Figure 3.8.4.2-3 Face import/export

3.8.5. Unlock via HTTP Command

Login to the website and go to the path **Intercom - Relay - Open Relay via HTTP** to configure. Users can use a URL to remotely unlock the door. It is more convenient for users to open the door if users are not beside the devices.

Switch: Enable this function. Disable by default.

Username & Password: Users can setup the username and password for HTTP unlock.

URL format:

`http://IP_address/fcgi/do?action=OpenDoor&UserName=&Password=&DoorNum=1`

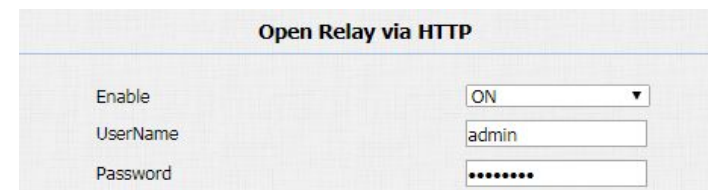

Open Relay via HTTP	
Enable	ON
UserName	admin
Password	*****

Figure 3.8.5 Open relay via HTTP

3.8.6. Unlock via Exit Button

R29 series supports 3 input triggers Input A/B/C (DOORA/B/C). Login to the website and go to the path **Intercom - Input** to configure.

Input Service: To enable or disable input trigger service.

Trigger Option: To choose open circuit trigger or closed circuit trigger. “Low” means that connection between door terminal and GND is closed, while “High” means the connection is opened.

Door Status: To show the status of input signal.

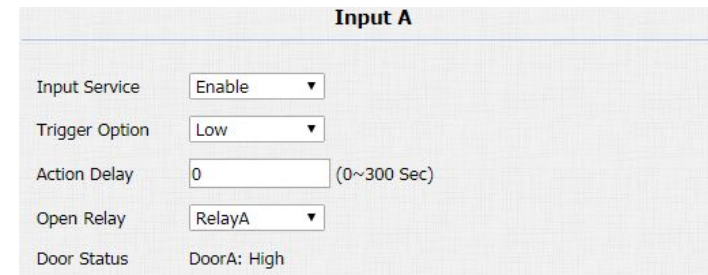

Input A	
Input Service	Enable ▼
Trigger Option	Low ▼
Action Delay	0 (0~300 Sec)
Open Relay	RelayA ▼
Door Status	DoorA: High

Figure 3.8.6 Input

3.9. Reboot

In the phone interface, go to **Reboot** to click the Reboot, or go to the path **Upgrade - Basic** on the web GUI, click **Submit**, the device will restart.

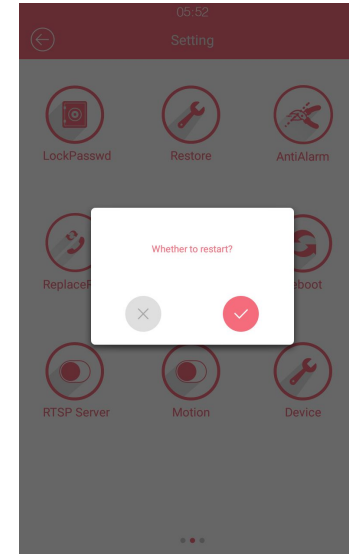



Figure 3.9-1 Reboot



Figure 3.9-2 Reboot

3.10. Reset

In the phone interface, go to **Restore**. Click **Restore**, if users sure to restore to factory settings, please choose  in the prompt window.

Users can also login to the website and go to the path **Upgrade - Basic**, directly click **Submit** to reset R29 series. Use this function with caution. All configuration will be removed.

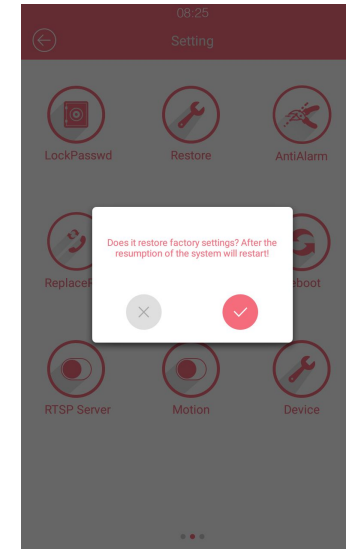

Figure 3.10-1 Restore



Figure 3.10-2 Reset

4. Advanced Features

4.1. Phone Configuration

4.1.1. IR LED

The setting is for night vision, when the surrounding of R29 series is very dark, infrared LED will turn on and R29 series will turn to night mode to let the users see video clearly from the R29S/F.

In the phone interface, go to **LED** or go to the path **Intercom - Advanced - LED** on web GUI, to configure the IR LED function.

Led Type: It can supports three modes - OFF, ON, AUTO. If setup the LED type as auto, click **Threshold button** to sense the intensity of the current environment.

Threshold: Click the **Threshold key**, it will automatic show the current intensity or user can setup the value manually. Once the environment intensity is darker than the predefined threshold value, LED will be up.

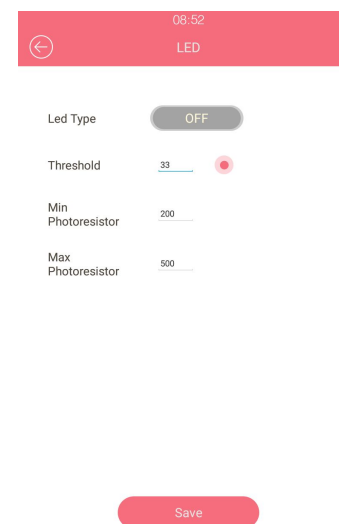

Figure 4.1.1-1 LED

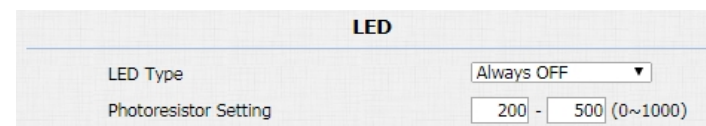

Figure 4.1.1-2 LED

Min/Max photoresistor: Photoresistor value relates to light intensity and larger value mean that light intensity is smaller. When photoresistor value is greater than max value, LED will turn on. In contrast, when photoresistor value is less than min value, infrared LED will turn off and the device turns to normal mode.

4.1.2. LED of Display

Login to the website and go to the path **Intercom - LED Setting - LED Control** to configure.

Card LED Enable: To control the LED of the card reader area.

Start Time (H): Setup the LED light up time. According to the system time. For example 18-23 means the LED will continuously light up from 6:00pm to 11:00pm.

4.1.3. RFID Card Code Display Related

Login to the website and go to the path **Intercom - Advanced -**



LED Control	
Card LED Enable	Enabled ▼
Start Time (H)	16 - 23 (0~23)

Figure 4.1.2 LED control



RFID	
RFID Display Mode	8HN ▼
IDCARD Display Mode	8HN ▼
WIEGAND Display Mode	8HN ▼

Figure 4.1.3 RFID

RFID to configure.

Display Mode: To be compatible different card number formats in different systems. The default 8HN means hexadecimal.

4.2. Intercom

4.2.1. Call Time Related

RTP Timeout: Login to the website and go to the path **Intercom - Basic - Door Setting General** to configure. This feature is specially designed for R47P. When R47P auto answer in mute status, if over the configured time R29 series did not receive the RTP message, R29 series will hang up automatically.

Max Call Time: Login to the website and go to the path **Intercom - Basic - Max Call Time** to configure the max call time.

Login to the website and go to the path **Intercom - Basic - Max**



A screenshot of a web interface showing a configuration field for 'RTP TimeOut'. The field is a text input box containing the number '20'. The label 'RTP TimeOut' is positioned to the left of the input box.

Figure 4.2.1 -1 RTP timeout

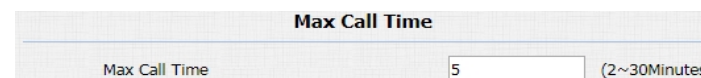

A screenshot of a web interface showing a configuration field for 'Max Call Time'. The field is a text input box containing the number '5'. To the right of the input box, the text '(2~30Minutes)' is displayed. The label 'Max Call Time' is positioned to the left of the input box. The title 'Max Call Time' is centered above the input field.

Figure 4.2.1 -2 Max call time

Dial Time to configure the max dail time.

Dial In Time: To configure the max incoming dial time, available when auto answer is disabled.

Dial Out Time: To configure the max no answer call time.

4.2.2. Return Code When Refused

Login to the website and go to **Phone - Call Feature - Others** to configure.

Return Code When Refuse: Allows users to assign specific code as return code to SIP server when an incoming call is rejected.

4.2.3. SIP Call Related

Login to the website and go to the path **Account - Advanced - Call** to configure the SIP call related functions.

Max Local SIP Port: To configure maximum local SIP port for designated SIP account.

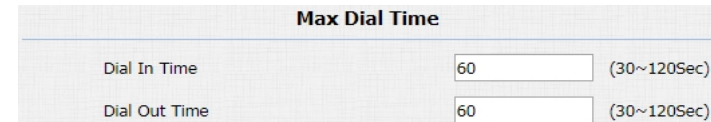

Max Dial Time		
Dial In Time	<input type="text" value="60"/>	(30~120Sec)
Dial Out Time	<input type="text" value="60"/>	(30~120Sec)

Figure 4.2.1 -3 Max dial time

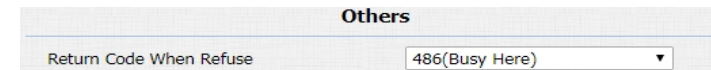

Others	
Return Code When Refuse	<input type="text" value="486(Busy Here)"/>

Figure 4.2.2 Return code when refused

Min Local SIP Port: To configure minimum local SIP port for designated SIP account.

Caller ID Header: To choose caller ID header format automatically.

Anonymous Call: If enabled, R29 series will block its information when calling out.

Anonymous Call Rejection: If enabled, calls who block their information will be screened out.

Missed Call Log: If enabled, any missed call will be recorded into call log.

Prevent SIP Hacking: If enabled, it will prevent sip message from hacking

4.2.4. Call Waiting

Login to the website and go to the path **Phone - Call Feature - Call Waiting** to configure.

Call Waiting Enable: If enabled, it allows IP phones to receive a

Call		
Max Local SIP Port	5062	(1024~65535)
Min Local SIP Port	5062	(1024~65535)
Caller ID Header	FROM	▼
Auto Answer	Enabled	▼
Provisional Response ACK	Disabled	▼
Register with user=phone	Disabled	▼
Invite with user=phone	Disabled	▼
Anonymous Call	Disabled	▼
Anonymous Call Rejection	Disabled	▼
Missed Call Log	Enabled	▼
Prevent SIP Hacking	Disabled	▼

Figure 4.2.3 SIP call related

new incoming call when there is already an active call.

Call Waiting Tone: If enabled, it allows IP phones to play the call waiting tone to the waiting callee.

On Code: The code used to enable call waiting on server's side, if configured, IP phone will send a SIP message to server to turn on call waiting on server side if user setup calls waiting is disabled.

Off Code: The code used to disable call waiting on server's side, if configured, IP phone will send a SIP message to disable call waiting on server side if user setup call waiting is enabled.

4.2.5. Intercom

Intercom allows users to establish a call directly with the callee.

Login to the website and go to the path **Phone - Call Feature -**

Intercom to configure.

Active: To enable or disable Intercom feature.

Intercom Mute: If enabled, once the call established, the callee will be muted.

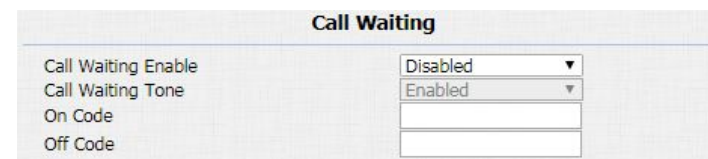

The screenshot shows a configuration window titled "Call Waiting". It contains four rows of settings:

Call Waiting	
Call Waiting Enable	Disabled
Call Waiting Tone	Enabled
On Code	
Off Code	

Figure 4.2.4 Call waiting

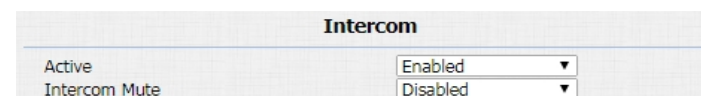

The screenshot shows a configuration window titled "Intercom". It contains two rows of settings:

Intercom	
Active	Enabled
Intercom Mute	Disabled

Figure 4.2.5 Intercom

4.2.6. Codec

Login to the website and go to the path **Account - Advanced** to configure the video codec and audio codec.

● Audio Codec

Sip Account: To choose which account to configure.

Audio Codec: R29 series supports four audio codec: PCMA, PCMU, G729, G722. Different audio codec requires different bandwidth, user can enable/disable them according to different network environment.

Note: Bandwidth consumption and sample rates.

Codec	Bandwidth	Sample Rates
PCMA	64kbit/s	8kHz
PCMU	64kbit/s	8kHz
G729	8kbit/s	8kHz
G722	64kbit/s	16kHz

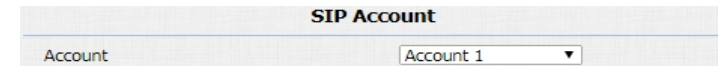

Figure 4.2.6-1 SIP account

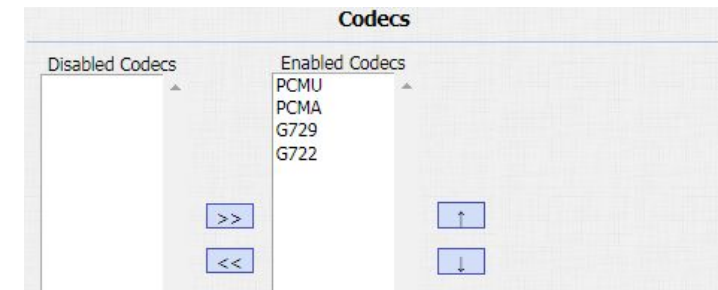

Figure 4.2.6-2 Audio codec

● Video Codec

R29 series supports H264 standard, which provides better video quality at substantially lower bit rates than previous standards.

Codec Resolution: R29 series supports four resolutions: QCIF, CIF, VGA, 4CIF and 720P.

Codec Bitrate: To configure bit rates of video stream.

Codec Payload: To configure RTP audio video profile

4.2.7. DTMF

Login to the website and go to the path **Account - Advanced - DTMF** to configure RTP audio video profile for DTMF and its payload type.

Type: Support Inband, Info, RFC2833 or their combination.

How To Notify DTMF: Only available when DTMF type is Info.

DTMF Payload: To configure payload type for DTMF.



The screenshot shows a configuration panel titled "Video Codec". It contains four rows of settings:

Video Codec	
Codec Name	<input checked="" type="checkbox"/> H264
Codec Resolution	4CIF
Codec Bitrate	320
Codec Payload	104

Figure 4.2.6-3 Video codec



The screenshot shows a configuration panel titled "DTMF". It contains three rows of settings:

DTMF	
Type	RFC2833
How To Notify DTMF	Disabled
DTMF Payload	101 (96~127)

Figure 4.2.7 DTMF

4.2.8. Session Timer

Go to the path **Account - Advanced - Session Timer** on the web GUI to configure. If enabled, the on going call will be disconnected automatically once the session expired unless it's been refreshed by UAC or UAS.

4.2.9. NAT

Login to the website and go to the path **Account - Advanced - NAT** to configure.

UDP Keep Alive Messages: The phone will send UDP keep-alive message periodically to router to keep NAT port alive.

UDP Alive Msg Interval: Keep alive message interval.

Rport: It will add remote port into outgoing SIP message for designated account.

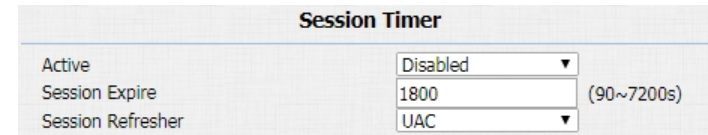

Session Timer	
Active	Disabled ▼
Session Expire	1800 (90~7200s)
Session Refresher	UAC ▼

Figure 4.2.8 Session timer

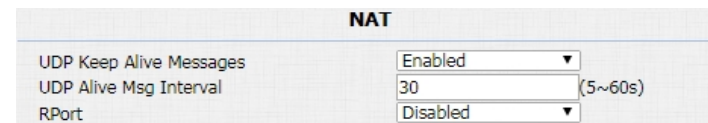

NAT	
UDP Keep Alive Messages	Enabled ▼
UDP Alive Msg Interval	30 (5~60s)
RPort	Disabled ▼

Figure 4.2.9 NAT

4.2.10. User Agent

Login to the website and go to the path **Account - Advanced - User Agent** to configure.

User Agent: One can customize users agent field in the SIP message; if user agent is set to specific value, users can see the information from PCAP. If user agent is not set by default, users can see the company name, model number and firmware version from PCAP.

4.3. Access control

4.3.1. Webrelay

R29 series supports extra web relay. This function is more safety to use DTMF code to remote unlock. Login to the website and go to the path **Phone - Web Relay** to configure.

- **Web Relay**

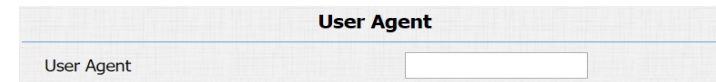

Figure 4.2.10 User Agent

Type: Connect web relay and choose the type.

IP Address: Enter web relay IP address.

User Name: It is an authentication for connecting web relay.

password: It is an authentication for connecting web relay.

Note: Users can modify username and password in web relay website.

● Web Relay Action Setting

Web Relay Action: Web relay action is used to trigger the web relay. The action URL is provided by web relay vendor

Web Relay Key: If the DTMF keys same as the local relay, the web relay will be open with local relay. But if there are different, the web relay is invalid.

Web Relay Extension: The webrelay can only receive the DTMF signal from the corresponding extension number.



The image shows a configuration form titled "Web Relay". It contains four fields: "Type" with a dropdown menu set to "Default", "IP Address" with an empty text box, "UserName" with an empty text box, and "Password" with a masked text box containing seven dots.

Figure 4.3.1-1 Web relay

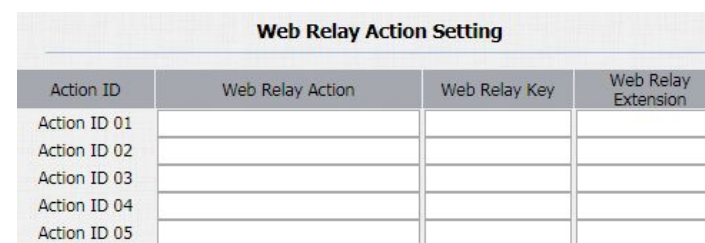

Web Relay Action Setting			
Action ID	Web Relay Action	Web Relay Key	Web Relay Extension
Action ID 01			
Action ID 02			
Action ID 03			
Action ID 04			
Action ID 05			

Figure 4.3.1-2 Web relay action setting

4.3.2. Wiegand

Login to the website and go to the path **Intercom - Advanced - Wiegand** to configure.

Wiegand Type: Support Wiegand 26,34,58. The different number means different bits.

Wiegand Mode: Input or output. Typically, when you select input, we generally connect the wiegand input device, such as the wiegand card reader. Or R29 series can be used as output, It is generally used to connect the third-party Access Control, then R29 series change the card information as wiegand signal, then transfer to the access control module.

Wiegand Input/Output Order: To make the data from wiegand devices to be normal order or reversed order.

Wiegand Output CRC: To be compatible with the other three party wiegand access control which do not use the standard wiegand order, CRC can correct the order format.



Wiegand	
Wiegand Type	Wiegand-26 ▼
Wiegand Mode	Input ▼
Wiegand Input Order	Normal ▼
Wiegand Output Order	Normal ▼
Wiegand Output CRC	ON ▼

Figure 4.3.2 Wiegand

4.4. Security

4.4.1. Antialarm of Door Phone

4.4.1.1. Antialarm in device

In the phone interface, go to **AntiAlarm** to configure it.

This function is used to trigger the alarm by perceiving the change of gravity. After the door phone has been installed, administrator can enable Antialarm function. if the device is moved illegally, the gravity of R29 series are different from the original status, then the device will ring alarm bell and send out the call to the predefined location. The detailed gravity sensor value can be adjusted in website.

Tamper Proof Switch: Switch this feature.

Tamper Proof Switch: The smaller the value, the more sensitive the gravity sensor is.

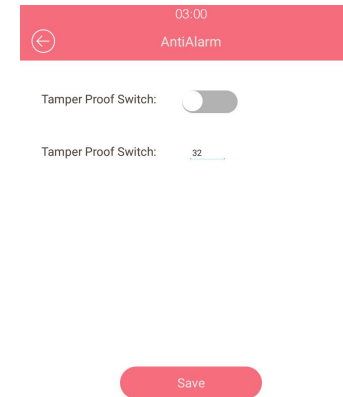

Figure 4.4.1.1 Antialarm

4.4.1.2. Antialarm in website

Login to the website and go to the path **Intercom - Advanced - Tamper Alarm** to configure.

R29 series integrates internal gravity sensor for the own security, and after enabling tamper alarm, if the gravity of R29 series changes dramatically, the phone will alarm. Gravity sensor threshold stands for sensitivity of sensor.

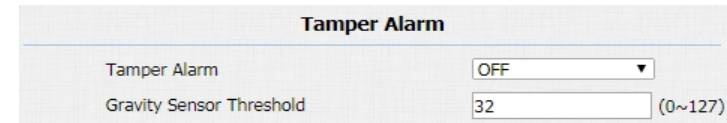

Figure 4.4.1.2 Tamper alarm

4.4.2. Motion

4.4.2.1. Motion in device

In the phone interface, go to **Motion** to configure. By enabling the motion detection function, the door phone will detect and record any change in the surrounding, such as suspicious people loitering around, and send notification message to a monitor unit.

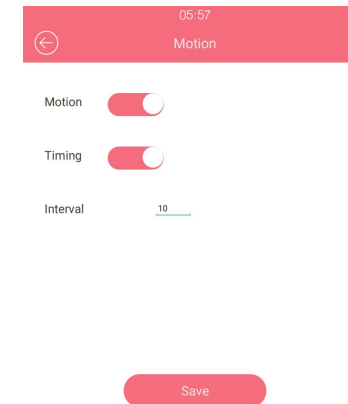

Figure 4.4.2.1 Motion

Timing setting

If users only enable time mode and setup the interval. R29 series will take the picture in every interval time;

Only enable detection mode, R29 series will capture if there is any change of surrounding in the detection time;

Enable timing mode and detection mode in the same time, if there is no any change of surrounding, R29 series will capture in the interval time. Otherwise, the device will take the picture in detection mode.

4.4.2.2. Motion in website

Login to the website and go to the path **Intercom - Motion - Motion Detection Options** to configure.

Motion Detection: To enable or disable motion detection.

Timing: If users only enable time mode and setup the interval . R29 series will take the picture in every interval time.

Notification: It supports two types FTP and EMAIL.

Motion Detection Options	
Enable	OFF
Timing	OFF
Notification	FTP
Timing Interval	10 (0~65535 Seconds)
Detection Delay	60
Capture Delay	10
Detection Accuracy	20

Figure 4.4.2.2 Motion detection options

Timing Interval: R29 series will take the picture in the interval time.

Detection Delay: Setup the time interval for detection.

Capture Delay: Setup the capture delay time.

Detection Accuracy: The smaller value, the capture picture is more accurate.

After you setup motion, to configure the target address where to receive the pictures.

4.4.3. Action

Login to the website and go to the path **Intercom - Action** to configure the action related features.

4.4.3.1. Email Notification

The capture will be send to the predefined email address or FTP path. It is useful for users to check the capture picture for security.

Sender's email address: To configure email address of sender.

Receiver's email address: To configure email address of receiver.

SMTP server address: To configure SMTP server address of sender.

SMTP user name: To configure user name of SMTP service (usually it is same with sender's email address).

SMTP password: To configure password of SMTP service (usually it is same with the password of sender's email).

Email subject: To configure subject of email.

Email content: To configure content of email.

Email Test: To test whether email notification is available.

4.4.3.2. FTP Notification

FTP Server: To configure URL of FTP server.

FTP User Name: To configure user name of FTP server.

FTP Password: To configure password of FTP server.

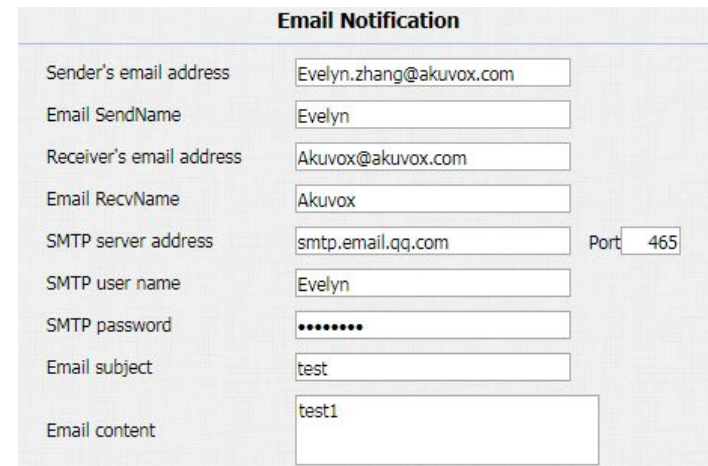

The screenshot shows a configuration form titled "Email Notification". It contains the following fields and values:

Email Notification	
Sender's email address	Evelyn.zhang@akuvox.com
Email SendName	Evelyn
Receiver's email address	Akuvox@akuvox.com
Email RecvName	Akuvox
SMTP server address	smtp.email.qq.com
Port	465
SMTP user name	Evelyn
SMTP password	*****
Email subject	test
Email content	test1

Figure 4.4.3.1 Email notification

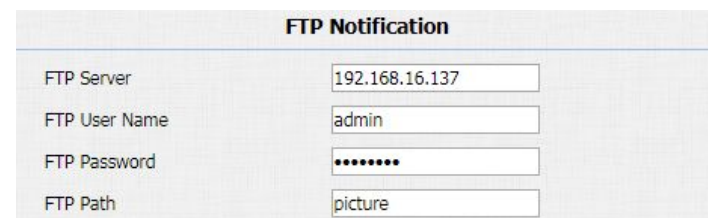

The screenshot shows a configuration form titled "FTP Notification". It contains the following fields and values:

FTP Notification	
FTP Server	192.168.16.137
FTP User Name	admin
FTP Password	*****
FTP Path	picture

Figure 4.4.3.2 FTP notification

FTP Path: Enter the folder name you created in FTP server.

4.4.3.3. Input Interface Triggered Action

Go to the path **Intercom - Input** on the website to configure.

Action Delay: To configure after how long to execute to send out notifications and trigger relay.

Open Relay: To configure which relay to trigger.

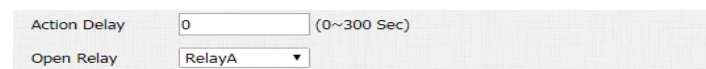

Action Delay	<input type="text" value="0"/>	(0~300 Sec)
Open Relay	<input type="text" value="RelayA"/>	

Figure 4.4.3.3 Input interface triggered action

4.5. Upgrade

4.5.1. Web Update

Login to the website and go to the path **Upgrade - Basic**, users can upgrade firmware.

Upgrade: Choose .zip/.rom firmware from your PC, then click Submit to start update.

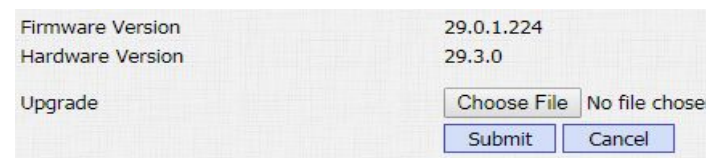

Firmware Version	29.0.1.224
Hardware Version	29.3.0
Upgrade	<input type="button" value="Choose File"/> No file chosen
	<input type="button" value="Submit"/> <input type="button" value="Cancel"/>

Figure 4.5.1 Web update

4.5.2. Autop Upgrade

Login to the website and go to the path **Upgrade - Advanced** to configure.

● Manual Autop

Autop is a centralized and unified upgrade of IP telephone. It is a simple and time-saving configuration for IP phone. It is mainly used by the device to download corresponding configuration document from the server using TFTP / FTP / HTTP / HTTPS network protocol. To achieve the purpose of updating the device configuration, making the user to change the phone configuration more easily. This is a typical C/S architecture upgrade mode, mainly by the terminal device or PBX server to initiate an upgrade request.

URL: Auto provisioning server address.

User name: Configure if server needs an username to access, otherwise left blank.

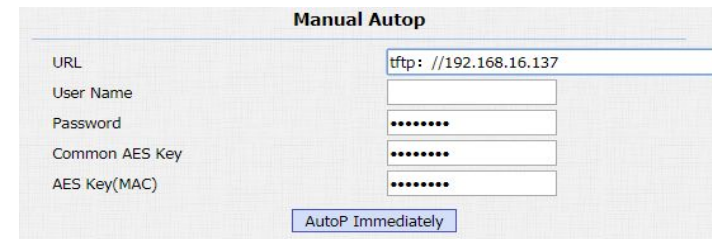

The screenshot shows a web interface titled "Manual Autop". It features a list of configuration fields on the left and their corresponding input boxes on the right. The "URL" field is populated with "tftp://192.168.16.137". The "User Name" field is empty. The "Password", "Common AES Key", and "AES Key(MAC)" fields are masked with dots. At the bottom of the form is a button labeled "AutoP Immediately".

Figure 4.5.2-1 Manual Autop

Password: Configure if server needs a password to access, otherwise left blank.

Common AES Key: Used for IP phone to decipher common Auto Provisioning configuration file.

AES Key (MAC): Used for IP phone to decipher MAC-oriented auto provisioning configuration file (for example, file name could be 0c1105888888.cfg if IP phone's MAC address is 0c1105888888).

Note: AES is one of many encryption, it should be configured only when configure file is ciphered with AES, otherwise left blank.

● Automatic Autop

To display and configure Auto Provisioning mode settings.

This Auto Provisioning mode is actually self-explanatory.

For example, mode "Power on" means IP phone will go to do Provisioning every time it powers on.

● DHCP Option

To display and configure DHCP setting for AutoP. Option 66/43 is enable by default. It can support Https, Http, Ftp, Tftp server.

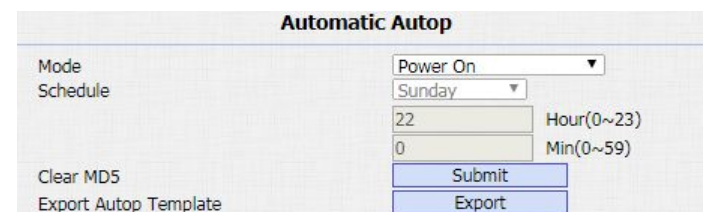

Figure 4.5.2-2 Automatic Autop

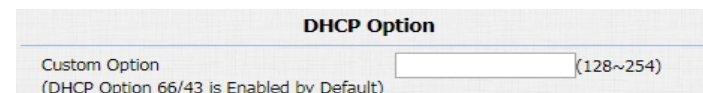

Figure 4.5.2-3 DHCP option

Customer Option: Enter the server URL. Click **Submit** to save.

4.5.3. Backup Config File

Go to the path **Upgrade - Advanced - Others** to backup the config file.

Others: To export current config file or import new config file.

Note: The exported config is encrypted.

Users can also go to the path **Phone - Import/Export - Import/Export Config&Contact** to export or import the config. Click **Export** to export the config file. And users can modify configuration item in config file then import it from local side.

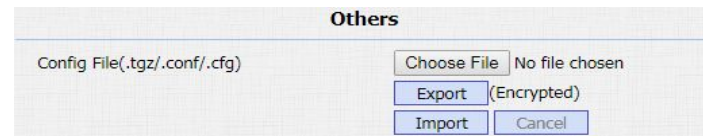

Figure 4.5.3-1 Config

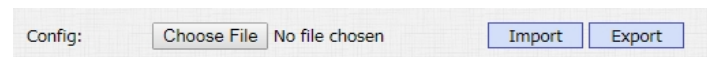
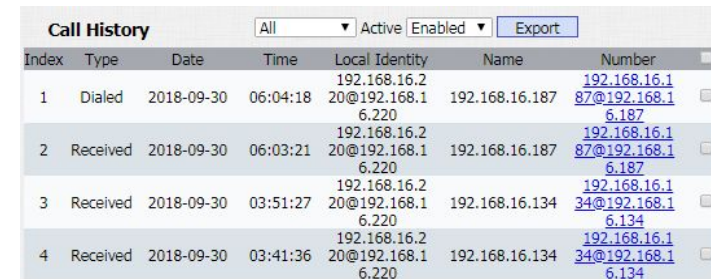

Figure 4.5.3-2 Config

4.6. Log

4.6.1. Call Log

Login to the website and go to the path **Phonebook - Call Log**, users can see a list of call which have dialed, received or missed. And user can delete calls from list.



The screenshot shows the 'Call History' interface. At the top, there is a filter dropdown set to 'All', a status dropdown set to 'Active', and an 'Enabled' dropdown. An 'Export' button is located to the right. Below this is a table with the following columns: Index, Type, Date, Time, Local Identity, Name, and Number. There are four rows of data, each with a checkbox in the rightmost column.

Index	Type	Date	Time	Local Identity	Name	Number	
1	Dialed	2018-09-30	06:04:18	192.168.16.2 20@192.168.1 6.220	192.168.16.187	192.168.16.1 87@192.168.1 6.187	<input type="checkbox"/>
2	Received	2018-09-30	06:03:21	192.168.16.2 20@192.168.1 6.220	192.168.16.187	192.168.16.1 87@192.168.1 6.187	<input type="checkbox"/>
3	Received	2018-09-30	03:51:27	192.168.16.2 20@192.168.1 6.220	192.168.16.134	192.168.16.1 34@192.168.1 6.134	<input type="checkbox"/>
4	Received	2018-09-30	03:41:36	192.168.16.2 20@192.168.1 6.220	192.168.16.134	192.168.16.1 34@192.168.1 6.134	<input type="checkbox"/>

Figure 4.6.1 Call log

4.6.2. Door Log

Login to the website and go to the path **Phone - Door Log**, users can see a list of door log which records card information and date.

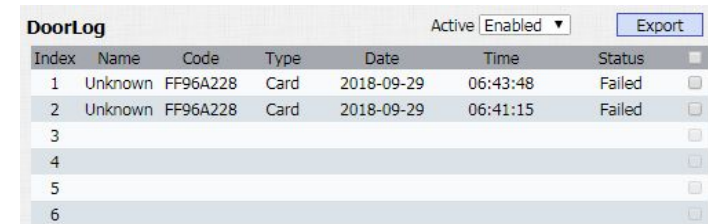

The screenshot shows the 'DoorLog' interface. At the top, there is a status dropdown set to 'Active' and an 'Enabled' dropdown. An 'Export' button is located to the right. Below this is a table with the following columns: Index, Name, Code, Type, Date, Time, and Status. There are six rows of data, each with a checkbox in the rightmost column.

Index	Name	Code	Type	Date	Time	Status	
1	Unknown	FF96A228	Card	2018-09-29	06:43:48	Failed	<input type="checkbox"/>
2	Unknown	FF96A228	Card	2018-09-29	06:41:15	Failed	<input type="checkbox"/>
3							<input type="checkbox"/>
4							<input type="checkbox"/>
5							<input type="checkbox"/>
6							<input type="checkbox"/>

Figure 4.6.2 Door log

4.6.3. System Log

Go to the path **Upgrade - Advanced - System Log** on web GUI. To display system log level and export system log file.

System Log Level: From level 0 to 7. The higher level means the more specific system log is saved to a temporary file. By default,

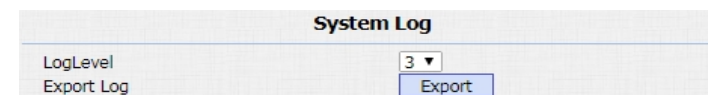

The screenshot shows the 'System Log' interface. It features a 'LogLevel' dropdown menu currently set to '3' and an 'Export' button.

LogLevel	Export
3	<input type="button" value="Export"/>

Figure 4.6.3 System log

it's level 3.

Export Log: Click to export temporary system log file to local PC.

4.6.4. PCAP

Go to the path **Upgrade - Advanced - PCAP** on web GUI. To start, stop packets capturing or to export captured Packet file.

Start: To start capturing all the packets file sent or received from IP phone.

Stop: To stop capturing packets.

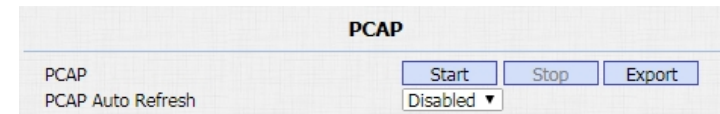

Figure 4.6.4 PCAP

Abbreviations

ACS: Auto Configuration Server

Auto: Automatically

AEC: Configurable Acoustic and Line Echo Cancelers

ACD: Automatic Call Distribution

Autop: Automatic Provisioning

AES: Advanced Encryption Standard

BLF: Busy Lamp Field

COM: Common

CPE: Customer Premise Equipment

CWMP: CPE WAN Management Protocol

DTMF: Dual Tone Multi-Frequency

DHCP: Dynamic Host Configuration Protocol

DNS: Domain Name System

DND: Do Not Disturb

DNS-SRV: Service record in the Domain Name System

FTP: File Transfer Protocol

GND: Ground

HTTP: Hypertext Transfer Protocol

HTTPS: Hypertext Transfer Protocol Secure

IP: Internet Protocol

ID: Identification

IR: Infrared

LCD: Liquid Crystal Display

LED: Light Emitting Diode

MAX: Maximum

POE: Power Over Ethernet

PCMA: Pulse Code Modulation A-Law

PCMU: Pulse Code Modulation μ -Law

PCAP: Packet Capture
PNP: Plug and Play
RFID: Radio Frequency Identification
RTP: Real-time Transport Protocol
RTSP: Real Time Streaming Protocol
MPEG: Moving Picture Experts Group
MWI: Message Waiting Indicator
NO: Normal Opened
NC: Normal Connected
NTP: Network Time Protocol
NAT: Network Address Translation
NVR: Network Video Recorder
ONVIF: Open Network Video Interface Forum

SIP: Session Initiation Protocol
SNMP: Simple Network Management Protocol
STUN: Session Traversal Utilities for NAT
SMTP: Simple Mail Transfer Protocol
SDMC: SIP Devices Management Center
TR069: Technical Report069
TCP: Transmission Control Protocol
TLS: Transport Layer Security
TFTP: Trivial File Transfer Protocol
UDP: User Datagram Protocol
URL: Uniform Resource Locator
VLAN: Virtual Local Area Network
WG: Wiegand

Contact us

For more information about the product, please visit us at www.akuvox.com or feel free to contact us by

Sales email: sales@akuvox.com

Technical support email: techsupport@akuvox.com

Telephone: +86-592-2133061 ext.7694/8162

We highly appreciate your feedback about our products.

